



# User Manual

## HD Wireless N Pan/Tilt Network Camera

DCS-5222L

# Manual Overview

D-Link reserves the right to revise this publication and to make changes in the content hereof without obligation to notify any person or organization of such revisions or changes. Information in this document may become obsolete as our services and websites develop and change. Please refer to the [www.mydlink.com](http://www.mydlink.com) website for the most current information.

## Manual Revisions

Revision	Date	Description
1.0	December 23, 2011	DCS-5222L Revision A1 with firmware version 1.00
1.1	June 05, 2011	DCS-5222L Revision A1 with firmware version 1.10
1.2	Aug 22, 2012	DCS-5222L Revision A1 with firmware version 1.20

## Trademarks

D-Link and the D-Link logo are trademarks or registered trademarks of D-Link Corporation or its subsidiaries in the United States or other countries. All other company or product names mentioned herein are trademarks or registered trademarks of their respective companies.

Copyright © 2012 by D-Link Corporation.

All rights reserved. This publication may not be reproduced, in whole or in part, without prior expressed written permission from D-Link Corporation.

# Safety Instructions

Use the following safety guidelines to ensure your own personal safety and to help protect your product from potential damage.

- If any of the following conditions occur, unplug the product from the electrical outlet and replace the part or contact the place of purchase:
  - The power cable, extension cable, or plug is damaged.
  - An object has fallen into the product.
  - The product has been exposed to water.
  - The product has been dropped or damaged.
  - The product does not operate correctly when you follow the operating instructions.
- Do not spill food or liquids on product, and never operate the product in a wet environment. If the product gets wet, see the appropriate section in your troubleshooting guide.
- Operate the product only from the type of external power source indicated on the electrical ratings label. If you are not sure of the type of power source required, consult your local power company.
- Use only the power adapter with the product. Using another adapter, not recommended by the manufacturer, may damage the product and invalidate the warranty.
- To help prevent an electric shock, plug the product into properly grounded electrical outlets.
- Observe power strip ratings. Make sure that the total ampere rating of all products plugged into the power strip does not exceed 80 percent of the ampere ratings limit for the power strip.
- To help protect your product from sudden, transient increases and decreases in electrical power, use a surge suppressor, line conditioner, or uninterruptible power supply (UPS).
- Position product cables and power cables carefully; route cables so that they cannot be stepped on or tripped over. Be sure that nothing rests on any cables. Do not modify power cables or plugs. Consult a licensed electrician or your power company for site modifications. Always follow your local/national wiring rules.

- The product is designed for indoor use only, and must always be positioned where it is not exposed to direct sunlight or strong halogen light. Exposure to direct sunlight or halogen light may cause permanent damage to the image sensor in the product.

## Warnings

- **STRANGULATION HAZARD!** – Keep cords out of the reach of children. Keep and secure all cords a minimum of 3 feet away from a crib or other child sleeping area.
- This product contains small parts that may cause choking. **Keep out of reach of children.**
- This product is not a toy. Do not allow children to play with it.
- The product is designed for **Indoor Use Only!**
- The product should not be used in a location where it could become wet!
- Ensure the product is fixed securely otherwise it may fall and cause injury!
- This product is NOT intended to replace proper supervision of children. You must check your child's activity regularly, as this product will not alert parents to activity of children.
- Do not use extension cords. Only use the power adapter provided.
- Do not use this product near a heat source.

**THIS DEVICE REQUIRES THIRD-PARTY SERVICES AND PRODUCTS TO ACHIEVE FULL FUNCTIONALITY, INCLUDING BUT NOT LIMITED TO, BROADBAND INTERNET SUBSCRIPTION SERVICES AND PRODUCTS; MOBILE INTERNET SUBSCRIPTION SERVICES, COVERAGE AND PRODUCTS; CAMERA MANAGEMENT SOFTWARE, AND; A NETWORK CONNECTION. D-LINK HAS NO CONTROL OVER SUCH SERVICES AND PRODUCTS AND EXPRESSLY DISCLAIMS ANY AND ALL LIABILITY FOR THE FAILURE OF THE DEVICE OR ANY FEATURE THEREOF RESULTING FROM THE FAILURE OF ANY THIRD-PARTY SERVICE OR PRODUCT.**

# Table of Contents

<b>Manual Overview.....</b>	<b>i</b>	<b>Configuration.....</b>	<b>14</b>
Manual Revisions.....	i	Configuration Utility.....	14
Trademarks .....	i	Live Video .....	15
Safety Instructions .....	ii	Setup.....	17
Warnings.....	iii	Setup Wizard .....	17
<b>Product Overview.....</b>	<b>1</b>	Internet Connection Setup Wizard.....	18
Package Contents.....	1	Network.....	22
System Requirements.....	2	Wireless .....	24
Introduction .....	3	Dynamic DNS .....	25
Features.....	4	Image Setup .....	26
Hardware Overview.....	5	Audio and Video.....	27
Front.....	5	Time and Date.....	29
Back.....	6	Video Clip .....	30
Wireless Installation Considerations.....	7	Snapshot.....	31
<b>Installation.....</b>	<b>8</b>	SD Recording.....	32
Camera Installation Wizard .....	8	Digital Output.....	33
WPS - Push Button Setup.....	9	Motion Detection .....	34
<b>mydlink Portal .....</b>	<b>10</b>	Camera Control .....	35
Camera Status.....	11	SD Management .....	36
Live Video .....	12	Maintenance .....	37
Camera Info .....	13	Admin .....	37
Playback.....	13	System .....	39
		Firmware Upgrade.....	40

Status .....	41
Device Info .....	41
Log .....	42
Help .....	43
Configuring the DCS-5222L with a Router .....	44
<b>Troubleshooting .....</b>	<b>50</b>
<b>Networking Basics .....</b>	<b>54</b>
Check your IP address .....	54
Statically Assign an IP Address .....	55
<b>Technical Specifications - Remote Control Unit .....</b>	<b>56</b>
<b>Technical Specifications - I/O Terminal Application .....</b>	<b>58</b>
<b>Technical Specifications .....</b>	<b>59</b>

# Product Overview

## Package Contents



DCS-5222L Network Camera



Antenna (optional)



Remote Control



Camera Base and Mounting Kit

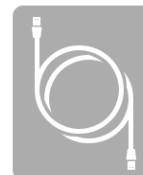

CAT5 Ethernet Cable



Power Supply



CD-ROM

**Note:** Using a power supply with a different voltage rating than the one included with the DCS-5222L will cause damage and void the warranty for this product. If any of the above items are missing from your package, please contact your retailer.

# System Requirements

<p><b>Network Requirements</b></p>	<ul style="list-style-type: none"> <li>• 10/100 Ethernet network or an 802.11n/g/b wireless network</li> </ul>
<p><b>CD Setup Wizard Requirements</b></p>	<ul style="list-style-type: none"> <li>• An Internet connection</li> <li>• A router connected to your broadband modem</li> </ul> <p><b>Computer with the following:</b></p> <ul style="list-style-type: none"> <li>• A PC with a wired connection to your router</li> <li>• Windows® 7 (32/64bit), XP (32/64bit), Vista® (32/64bit), Mac OS®X 10.5 or above</li> </ul>
<p><b>Web-based Configuration Utility Requirements</b></p>	<p><b>Browser Requirements:</b></p> <ul style="list-style-type: none"> <li>• Internet Explorer 7 or higher</li> <li>• Firefox 6.5 or higher</li> <li>• Safari 4 or higher</li> <li>• Chrome 8 or higher</li> </ul> <p><b>Windows® Users:</b> Make sure you have the latest version of Java installed. Visit <a href="http://www.java.com">www.java.com</a> to download the latest version.</p>
<p><b>mydlink Website Requirements</b></p>	<ul style="list-style-type: none"> <li>• Broadband Internet connection</li> <li>• Computer with:             <ul style="list-style-type: none"> <li>• Internet Explorer 7 or higher (ActiveX)</li> <li>• Firefox 6.5 or higher</li> <li>• Safari 4 or higher</li> <li>• Chrome 8 or higher</li> </ul> </li> </ul>



# Introduction

Congratulations on your purchase of the DCS-5222L Cloud Camera 5000. The DCS-5222L is a versatile solution for your small office or home. The DCS-5222L is a complete system with a built-in CPU and web server that transmits high quality video images for security and surveillance. It can be accessed remotely, and controlled from any PC/Notebook over your local network or across the Internet via a web browser. The DCS-5222L features 802.11n wireless connectivity, allowing the camera to be placed anywhere within range of your wireless network. The DCS-5222L comes with remote monitoring and motion detection features for a complete and cost-effective home security solution.

# Features

## **Simple to Use**

The DCS-5222L is a stand-alone system with a built-in CPU, requiring no special hardware or software such as PC frame grabber cards. The DCS-5222L supports both ActiveX mode for Internet Explorer and Java mode for other browsers such as Firefox, Chrome, and Safari.

## **Supports a Variety of Platforms**

The DCS-5222L supports TCP/IP networking, HTTP, and other Internet related protocols. It can also be integrated easily into other Internet/Intranet applications because of its standards-based features.

## **Web Configuration**

Using a standard Web browser, administrators can configure and manage the Network Camera directly from its own Web page via Intranet or Internet.

## **Broad Range of Applications**

With today's high-speed Internet services, the DCS-5222L Network Camera can provide an ideal solution for live video over the Internet and for remote monitoring. The DCS-5222L allow remote access from a Web browser for live image viewing and management of the network cameras anytime, from anywhere in the world. The network cameras have a wide range of applications, including industrial and public monitoring of homes, offices, banks, hospitals, child-care centers, and amusement parks.

## **802.11n Wireless or Ethernet/Fast Ethernet Support**

The DCS-5222L offers wireless 802.11n and Ethernet/Fast Ethernet connectivity, making the DCS-5222L easy to integrate into your existing network environment. The DCS-5222L works with a 10Mbps Ethernet based network or 100Mbps Fast Ethernet based network for traditional wired environments, and works with 802.11n routers or access points for added flexibility. The Site Survey feature also allows you to view and connect to any available wireless networks.

## **Remote Monitoring Utility**

The D-ViewCam application adds enhanced features and functionality for the Network Camera and allows administrators to configure and access the Network Camera from a remote site via Intranet or Internet. Other features include image monitoring, recording images to a hard drive, viewing up to 32 cameras on one screen, and taking snapshots. Note that D-ViewCam works on Windows® computers only.

## **IR LED for day and night functionality**

The built-in infrared LEDs enables night time viewing of up to 16 feet (5 meters).

# Hardware Overview

## Front



# Hardware Overview

## Back



### Audio Out

Connect headphones/speakers to provide audio out.

### I/O Connector

The 4-pin I/O connector provides an interface for photo-coupled switch output and photo-coupled input. An example of what can be done with a digital input and digital output is the connecting of a motion sensor to the port, signalling the camera to take a snapshot and trigger an alarm connected to the port.

### Ethernet Port

Connects to a PC or network through an Ethernet connection.

### Power Receptor

Connects to the power adapter.

### WPS Button

### Micro SD Slot

Used for storing recorded images and video

### Reset Button

Press and hold to reset to the default factory settings.

# Wireless Installation Considerations

The D-Link Wireless Network Camera lets you access your network using a wireless connection from anywhere within the operating range of your wireless network. However, the number, thickness and location of walls, ceilings, or other objects that the wireless signals must pass through, may limit the range. Typical ranges vary depending on the types of materials and background RF (radio frequency) noise in your home or business. The key to maximizing wireless range is to follow these basic guidelines:

1. Minimize the number of walls and ceilings between your adapter and other network devices (such as your Network Camera) - each wall or ceiling can reduce your adapter's range from 3-90 feet (1-30 meters).
2. Be aware of the direct line between network devices. A wall that is 1.5 feet thick (.5 meters), at a 45-degree angle appears to be almost 3 feet (1 meter) thick. At a 2-degree angle, it looks over 42 feet (14 meters) thick. Position your devices so that the signal will travel straight through a wall or ceiling (instead of at an angle) for better reception.
3. Building Materials make a difference. A solid metal door or aluminum studs may weaken the wireless signal. Try to position your access points, wireless routers, and other networking devices where the signal passes through drywall or open doorways. Materials and objects such as glass, steel, metal, walls with insulation, water (fish tanks), mirrors, file cabinets, brick, and concrete will degrade your wireless signal.
4. Keep your product at least 3-6 feet or 1-2 meters away from electrical devices or appliances that generate RF noise.
5. If you are using 2.4GHz cordless phones or other radio frequency sources (such as microwave ovens), your wireless connection may degrade dramatically or drop completely. Make sure your 2.4GHz phone base is as far away from your wireless devices as possible. The base transmits a signal even if the phone is not in use.

# Installation

## Camera Installation Wizard

Insert the Installation CD-ROM into your computer's CD drive to start the autorun program. Do not mount your camera until you have configured it.

The CD-ROM will open the Camera Installation Wizard. Simply click **Start** to go through the Installation Wizard, which will guide you through the installation process from connecting your hardware, configuring your camera, and registering with mydlink.com.

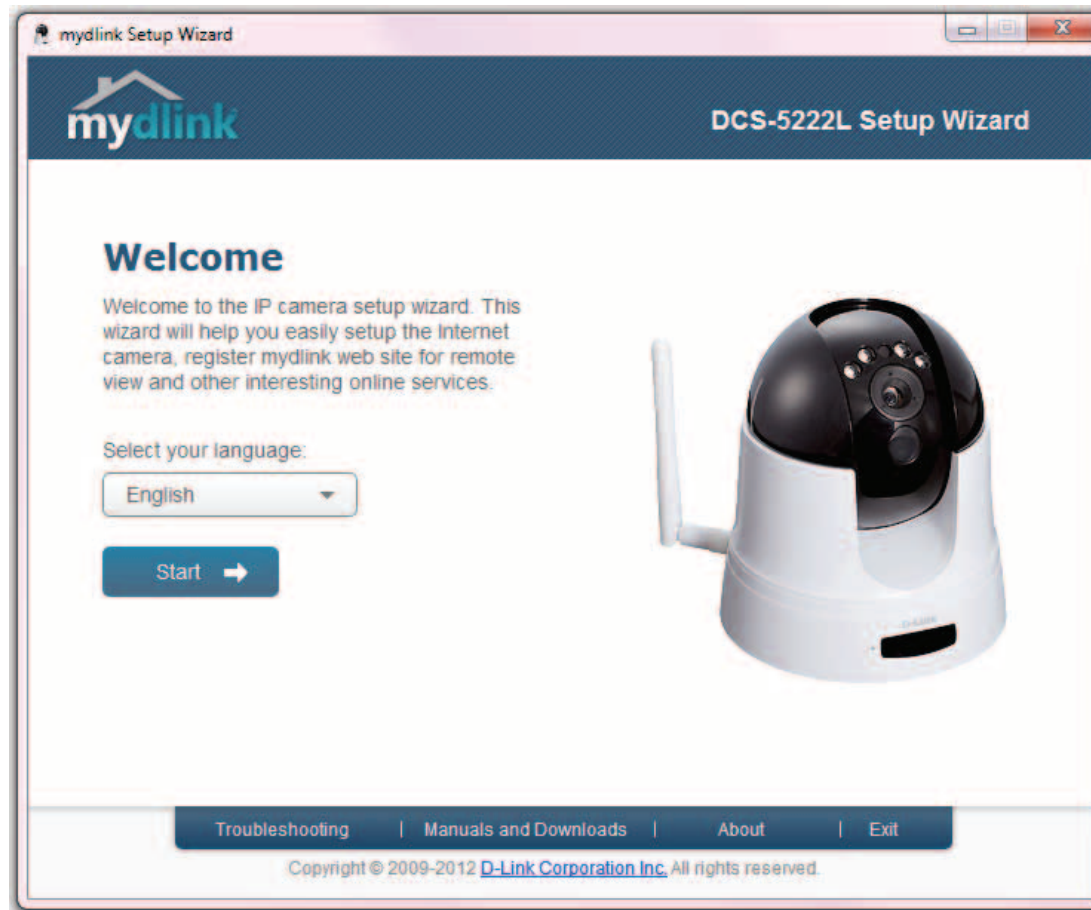

## WPS - Push Button Setup

Alternatively, you may create a connection to the camera using Wi-Fi Protected Setup (WPS).

### To create a WPS connection:

#### Step 1

Press and hold the WPS button for three seconds. The blue WPS status LED above the button will blink.

#### Step 2

Press the WPS button on your router or access point within 120 seconds. The WPS button is usually on the front or side of your router. On some routers and access points, you may need to log in to the web interface and click on an on-screen button to activate the WPS feature. If you are not sure where the WPS button is on your router/AP, please refer to your router or AP's User Manual.

The DCS-5222L will automatically create a wireless connection to your router or access point. While connecting, the green LED will flash and your camera will reboot.

**Note:** Your camera contains an internal antenna and it is not necessary to attach the external antenna unless you would like to boost your signal or install an outdoor enclosure. You must select which antenna you want to use in the **Setup > Wireless** section from the camera's web configuration utility (internal is set by default).



# mydlink Portal

After registering your DCS-5222L camera with a **mydlink** account in the Camera Setup Wizard. You will be able to remotely access your camera from the [www.mydlink.com](http://www.mydlink.com) website. After signing in to your **mydlink** account, you will see a screen similar to the following:

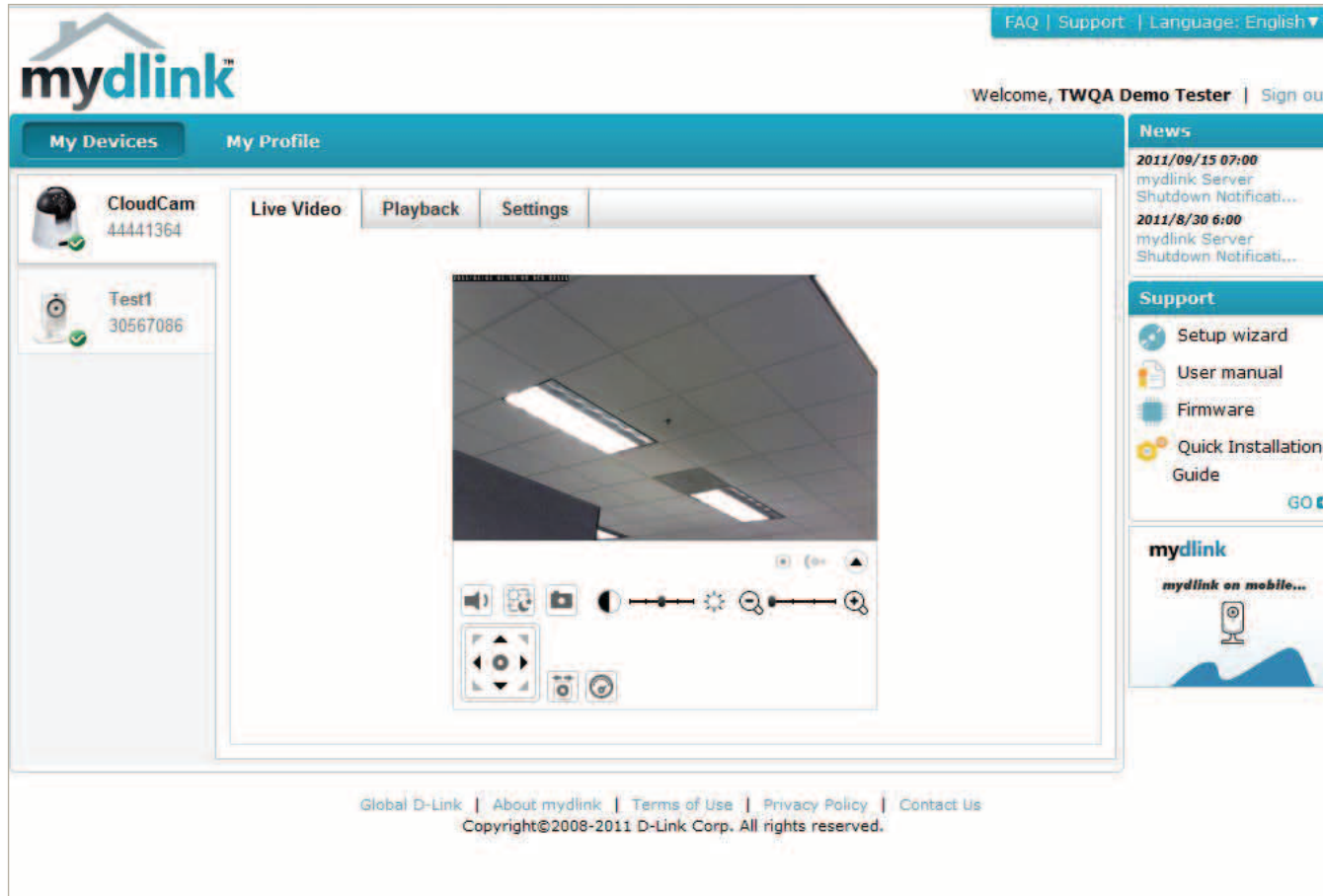



# Camera Status

The online status of each camera will be displayed. Your online status may be one of the following:



A green check mark indicates that your camera is online and ready to use.



A yellow exclamation point indicates that your camera is online, but the camera password has changed. You will need to enter your new camera password to access your camera again.



A red x indicates that your camera is offline and currently cannot be accessed remotely.

If your camera is offline, try the following:

- Check to make sure that the Internet connection to your camera is working properly.
- Try restarting your broadband router.
- Check your camera's cable connections and make sure they are secure.
- Check to make sure that the power LED on your camera is lit solid red.

If you still cannot access your camera, reset your camera and run the Camera Setup Wizard again from the CD-ROM included in your package.

LED Indicative	Color	Status	Description
<b>Link</b>	Green	Off	Link down
		On	Link up
		Blinking	monitoring
<b>Power</b>	Red	Off	Power Off
		On	Power on
<b>WPS</b>	Blue	Blinking (1 sec interval)	Setting is on going
		On	Success
		Blinking 10 seconds (0.1 sec interval) Off	Fail Standby

# Live Video

If the camera is available, a Live Video feed will be displayed. Video will be shown at full resolution if viewing your camera from a PC on the same local network, or viewing your camera from a PC on a remote network.

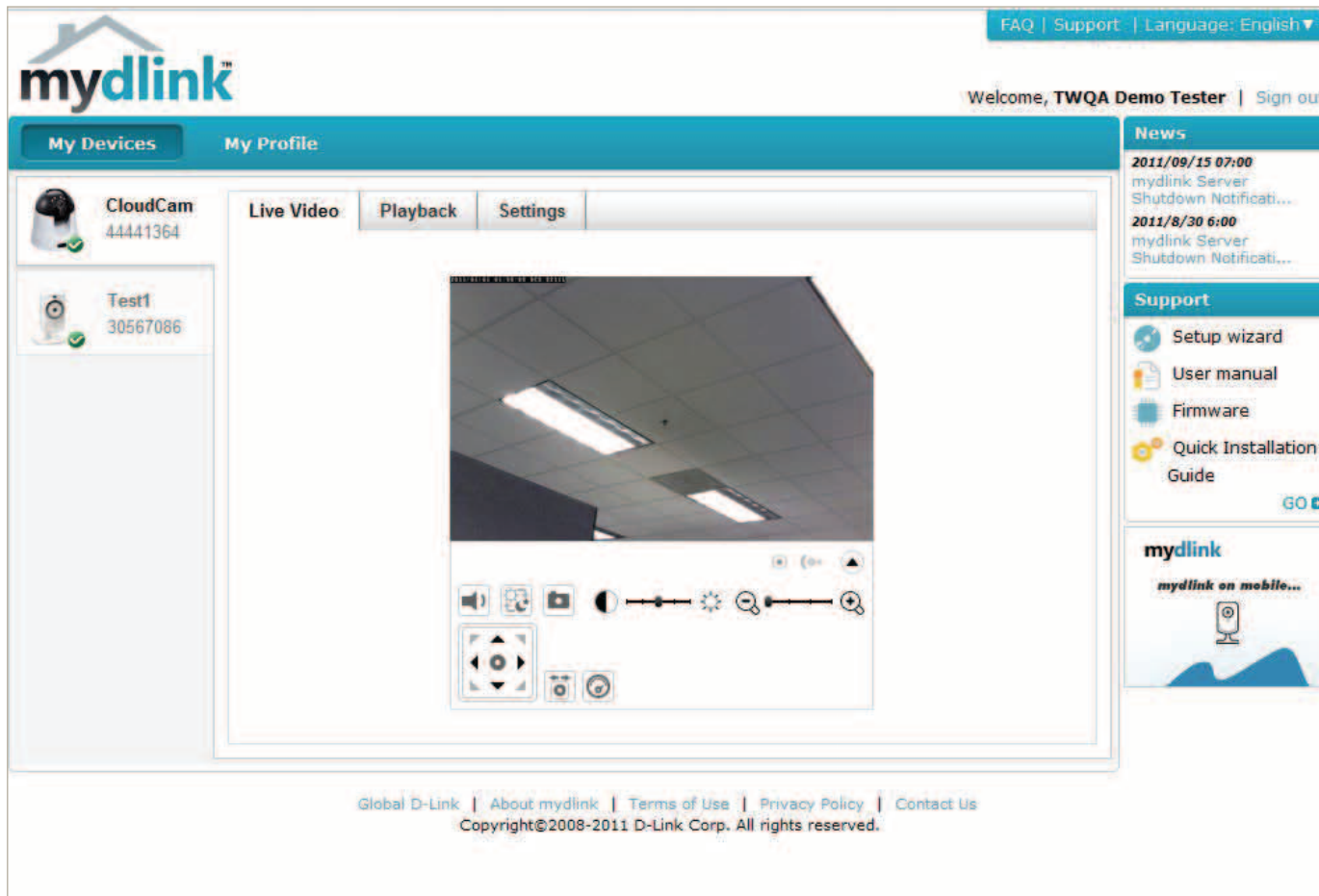

# Camera Info

The Camera Info tab displays various details about your camera.

**Device Name:** The Device Name is a unique name that you can give to your device to help you identify it. Clicking on the Device Name will open a window for you to log in to your camera's configuration interface. Then, it will open the Maintenance > Admin page where you can change your Device Name.

**mydlink No.:** Displays the mydlink number of your device.

**Model Name:** Displays the model name of your device.

**MAC:** Displays the MAC address of your device.

**Camera activated on:** Displays the time and date that your device was added to mydlink.

**Advanced Setting:** Click to configure advanced features for your camera. You will need to enter the username and password of your camera (not mydlink).

**Delete Camera:** Click to remove the camera from mydlink. To add the camera back, you will need to run the setup wizard from the CD.

## Playback

**Search for clips to view:** Search for a recording time after download or playback.



# Configuration

## Configuration Utility

After completing the Camera Installation Wizard, you are ready to use your camera. The camera's built-in Web configuration utility is designed to allow you to easily access and configure your DCS-5222L. At the end of the wizard, click **Go To Camera**, or enter the IP address of your camera into a web browser. To log in, enter your user name (**admin**) and the password you created in the Installation Wizard. If you did not create a password, the default password is blank. After entering your password, click **OK**.

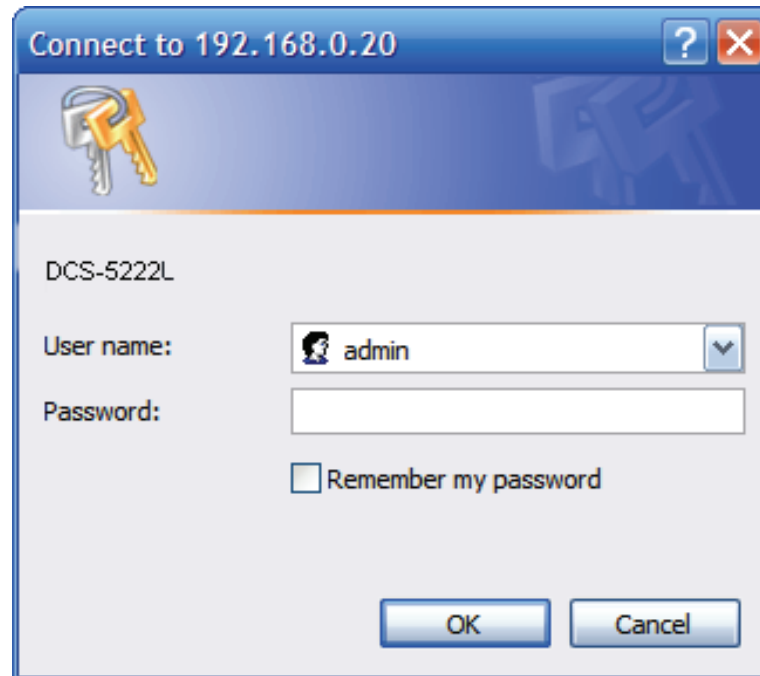

Connect to 192.168.0.20

DCS-5222L

User name:

Password:

Remember my password

OK Cancel

# Live Video

Please make sure that you have the latest version of Java application installed on your computer to ensure proper operation when viewing the video in Java mode. The Java application can be downloaded free from Sun's web site (<http://www.java.com>).

A live feed from the camera is displayed upon logging into the camera's web interface.

**P/T/Z Action Pad:** Use the **Pan / Tilt / Zoom** Action Pad to control the camera's movement and zoom. The large tree icon controls the zoom-in function. The small tree icon on the right side controls the zoom-out function. The **Home** button will move the camera to the "Home" preset position.

**Go To:** Select from the preset drop-down list to quickly move the camera to the desired preset position. Please refer to "camera control" setup to create preset positions.

**Pan/Tilt Speed:** This setting can change the camera's Pan/Tilt speed.









**Pan:** Press this button and the camera will pan from left-most position to the right-most position and then return to its original position.

**Stop:** This will stop pan and patrol.

**Patrol:** Click this button to quickly move the camera to the desired patrol setup according to preset positions. Please refer to "camera control" setup to create preset positions.

The next page contains several icons which can be used to control the camera's main functions.



Icon	Button Name	Function
	Profile buttons	Use these buttons to switch between video profiles. Refer to page 27 for more information on setting up profiles.
	Full Screen button	Displays the video at full screen.
	Snapshot button	Takes a snapshot of the image currently displayed on the screen and will save it to a file on the hard drive in a folder specified using the Storage folder button.
	Video recording button	Triggers the camera's recording function. This will record the video displayed on the screen and will save it to a file on the hard drive in a folder specified using the Storage folder button.
	Storage folder button	Sets the location to save snapshots and video recordings.
	Listen button	Sends the audio received from the camera's microphone through to the PC's speakers. Click again to turn off.
	Talk button	Sends audio from a microphone connected to your PC through to the speakers connected to the camera.
Zoom in/out: 	Zoom buttons	Zooms in or out.

# Setup

## Setup Wizard

You may choose to configure your network by using the **Internet Connection Setup Wizard** that includes step-by-step instructions to connect your camera to the Internet. Alternatively, you can manually configure your connection by clicking **Manual Internet Connection Setup**.

The screenshot displays the D-Link web interface for the DCS-5222L camera. The top navigation bar includes 'LIVE VIDEO', 'SETUP', 'MAINTENANCE', 'STATUS', and 'HELP'. The 'SETUP' section is active, showing a sidebar with various configuration options: Setup Wizard, Network, Wireless Setup, Dynamic DNS, Image Setup, Audio and Video, Time and Date, Video Clip, Snapshot, SD Recording, Digital Output, Motion Detection, Camera Control, SD Management, and Logout. The main content area is titled 'INTERNET CONNECTION SETTINGS' and contains the following text: 'In this section, you can setup the IP camera's network interface settings. If you are configuring this device for the first time, D-Link recommends that you select the Internet Connection Setup Wizard, and follow the instructions on screen. If you wish to modify or configure the IP camera settings manually, you may select the Manual Internet Connection Setup to input the network setting.' Below this text are two buttons: 'Internet Connection Setup Wizard' and 'Manual Internet Connection Setup'. A second section, 'IP CAMERA MOTION DETECTION SETTINGS', contains similar text and two buttons: 'Motion Detection Setup Wizard' and 'Manual Motion Detection Setup'. On the right side, a 'Helpful Hints..' sidebar provides additional guidance for advanced users.

**D-Link**

DCS-5222L // LIVE VIDEO SETUP MAINTENANCE STATUS HELP

Setup Wizard

**INTERNET CONNECTION SETTINGS**

In this section, you can setup the IP camera's network interface settings. If you are configuring this device for the first time, D-Link recommends that you select the Internet Connection Setup Wizard, and follow the instructions on screen. If you wish to modify or configure the IP camera settings manually, you may select the Manual Internet Connection Setup to input the network setting.

Internet Connection Setup Wizard Manual Internet Connection Setup

**IP CAMERA MOTION DETECTION SETTINGS**

In this section, you can setup the IP camera's Motion Detection settings. If you are configuring this device for the first time, D-Link recommends that you select the Motion Detection Setup Wizard, and follow the instructions on screen. If you wish to modify or configure the Motion Detection manually, select the Manual Motion Detection Setup.

Motion Detection Setup Wizard Manual Motion Detection Setup

**Helpful Hints..**

If you are an advanced user and have configured an Internet camera before, click 'Manual Internet Connection Setup' to input all settings manually.

If you consider yourself an advanced user and you want to manually set up motion detection settings, click 'Manual Motion Detection Setup' to input all the settings manually.

**SURVEILLANCE**

## Internet Connection Setup Wizard

This wizard will guide you through a step-by-step process to configure your new D-Link Camera and connect the camera to the Internet. **Note that this wizard will not register your camera with mydlink.com.**

Click **Next** to continue.

Select **Automatic IP Address** if you want your DHCP server (usually enabled on your router) to assign the camera its IP settings. If you want to manually assign the IP settings, select **Static IP Address** and enter the following details:

**IP Address:** Enter an IP address for your camera.

**Subnet Mask:** Enter the subnet mask of your network.

**Default Gateway:** Enter the default gateway address. This is usually the IP address of your router.

**Primary DNS:** Enter the primary DNS server's IP address. This is usually the IP address of your router.

**Secondary DNS:** Enter the secondary DNS server's IP address. This is optional.

Click **Next** to continue.

### WELCOME TO D-LINK SETUP WIZARD - INTERNET CONNECTION SETUP

This wizard will guide you through a step-by-step process to configure and connect your D-Link Camera to the Internet. For your camera motion detection settings, please click Back button to close this wizard and select the Motion Detection Setup Wizard.

- Step 1: LAN Settings
- Step 2: Internet Settings
- Step 3: DDNS Settings
- Step 4: Camera Name Settings
- Step 5: Time Zone
- Step 6: Setup Complete

Back Next Cancel

### STEP 1: LAN SETTINGS

Please select whether your camera will connect to the Internet with an Automatic or a Static IP Address. If your camera is connected to a router, or you are unsure which settings to pick, D-Link recommends that you keep the default selection of Automatic IP Address. Otherwise, select Static IP Address to manually assign an IP address before clicking on the Next button.

- Automatic IP Address  
 Static IP Address

IPv4 Address

Subnet Mask

Default Gateway (Router)

Optional Primary DNS

Optional Secondary DNS

Back Next Cancel



## Section 4 - Configuration

If you are required to connect using PPPoE, select **Enabled** and enter the Username and Password for your PPPoE connection. Only select this option if your camera is directly connected to your broadband modem. If it is on a network with a router or gateway, do not select.

Click **Next** to continue.

### STEP 2: INTERNET SETTINGS

If your ISP is using PPPoE, please enable this setting and enter your ISP Username and Password. Then, click on the Next button. Please contact your ISP if you do not know your Username and Password.

Enable

A Dynamic DNS account allows you to access your camera over the Internet when you have an IP address that changes each time you connect to the Internet. If you have a Dynamic DNS account, click **Enable** and enter the following details:

**Enable:** Click to enable the DDNS function.

**DDNS:** (Dynamic Domain Name Server) will hold a DNS host name and synchronize the public IP address of the modem when it has been modified. The username and password are required when using the DDNS service.

**Server Address:** Select your Dynamic DNS Server from the drop down menu.

**Host Name:** Enter the host name of the DDNS server.

**User Name:** Enter your username or email address used to connect to the DDNS.

**Password:** Enter your password used to connect to the DDNS server.

**Timeout:** You can setup how often the camera notifies the DDNS server of its current global IP address by entering a whole number in hours.

### STEP 3: DDNS SETTINGS

If you have a Dynamic DNS account and would like the camera to update the IP address automatically, please enable DDNS and enter your host information below. Then, click on the Next button to continue.

Sign up for D-Link's Free DDNS service at <http://www.DlinkDDNS.com>

Enable

Server Address  <<

Host Name

User Name

Password

Verify Password

Timeout  Hour

## Section 4 - Configuration

---

Create a unique name for your camera. Click **Next** to continue.

### STEP 4: CAMERA NAME SETTINGS

D-Link recommends that you rename your camera for easy accessibility. You can then identify and connect to your camera via this name. Please assign a name of your choice before clicking on the Next button.

Camera Name

Select the time zone that the camera is in so that scheduled events occur at the correct time. If your time zone observes daylight saving, check the **Enable Daylight Saving** box and select **Auto Daylight Saving** to have DST set automatically or select **Set date and time manually** to enable drop-down menus so that you can set the start and end time of daylight saving yourself.

Click **Next** to continue.

### STEP 5: TIME ZONE

Please configure the correct time to ensure that all events are triggered, captured and scheduled at the right time. Then, click on the Next button.

Time Zone

Enable Daylight Saving

Auto Daylight Saving

Set DST Manually

## Section 4 - Configuration

---

A summary of the options you selected is displayed for confirmation. If you are happy with the selected configuration, click **Apply** otherwise click **Back** to make the required changes.

### STEP 6: SETUP COMPLETE

Below is a summary of your camera settings. Click on the Back button to review or modify settings or click on the Apply button if all settings are correct. It is recommended to note down these settings in order to access your camera on the network or via your web browser.

IPv4 Address	192.168.0.20
IP Camera Name	DCS-5222L
Time Zone	(GMT-12:00) International Date Line West
DDNS	Enable
PPPoE	Enable

# Network

This section allows you to configure your LAN and Internet configuration.

**Automatic IP Address Select:** This option is used if you would like an IP address assigned to your camera automatically by the DHCP server (router). If the DHCP server does not exist you will need to manually configure this setting should no DHCP server exist.

**Static IP Address:** This option is used to manually configure your Camera's IP settings.

**HTTP Port:** This option allocates the HTTP port of the camera.

**RTSP Port:** This option allocates the RTSP port of the camera, the RTSP port allows connections using QuickTime or other supported media players.

**UPnP Enable:** UPnP™ (Universal Plug & Play) can be used to allow discovery of a camera as a UPnP device in your network.

**UPnP Port Forward:** If your router supports UPnP, your camera and router can communicate allowing the router to discover which ports are used by each camera automatically without the need to open ports or port forward.

**Bonjour:** Enabling Bonjour will allow discovery of cameras by Mac computers.

**D-Link**

DCS-5222L // LIVE VIDEO SETUP MAINTENANCE STATUS HELP

Setup Wizard  
Network  
Wireless Setup  
Dynamic DNS  
Image Setup  
Audio and Video  
Time and Date  
Video Clip  
Snapshot  
SD Recording  
Digital Output  
Motion Detection  
Camera Control  
SD Management  
Logout

**NETWORK**  
You can configure your LAN and Internet settings here.  
Save Settings Don't Save Settings

**LAN SETTINGS**

**LAN SETTINGS**

Automatic IP Address  
 Static IP Address  
 PPPoE

**PORT SETTINGS**

HTTP Port   
RTSP Port

**UPnP**

UPnP  
 UPnP Port Forward

**Apple**

Bonjour

Save Settings Don't Save Settings

**Helpful Hints..**

**Automatic IP Address**  
Select if you are running a DHCP server on your network and would like an IP address assigned to your camera automatically.

**Static IP Address**  
This option is used to configure your IP Camera with IP address matched your network settings.

**HTTP Port**  
Allocate the port of camera to allow you to connect via a standard web browser.

**RTSP Port**  
Allocate the port of camera to allow you to connect by using QuickTime or streaming mobile devices.

**UPnP**  
Enable UPnP will allow you to discover camera as an UPnP device in

**Note:** You *MUST* also set up your router/gateway for Port Forwarding/Mapping; this will enable remote viewing of your camera via the Internet. Please refer to your router's instruction manual on how to open up ports (port forward). For additional help on configuring your camera to work with your router, please refer to **Appendix A: Installing the DCS-5222L on a Router Without UPnP**. For installing multiple cameras, ONE port per camera must be opened on your router, the Web server (HTTP) port. Also, some browsers may restrict some ports, such as 1 or 22, for security purposes. If you have problems accessing your camera through HTTP, try using a port higher than 1024.

After making any changes, click the **Save Settings** button to save your changes, or click the **Don't Save Settings** button to discard your changes.

# Wireless

To set up your Network camera's wireless network interface settings, enable **Wireless Settings** in this window first. Then continue the further configuration next.

**Site Survey:** Click the **Rescan** button to scan for available wireless networks. After scanning, select a wireless network from the drop-down box that you want to connect to.

**SSID:** The name of the wireless network.

**Wireless Mode:** Use the drop-down box to select the mode of the wireless network you wish to connect to. **Infrastructure** is normally used to connect to an access point or router. **Ad-Hoc** is usually used to connect directly to another computer.

**Channel:** If you are using Ad Hoc mode, select the channel of the wireless network you wish to connect to, or select **Auto**.

**Security Mode:** Select the type of authentication you are using on your wireless network (**Open**, **Shared (WEP)**, **WPA-PSK**, or **WPA-PSK2**).

**Cypher Type:** If you are using **WPA-PSK** or **WPA-PSK2** authentication, you will need to specify whether your wireless network uses TKIP or AES encryption. If you use **Open** or **Shared** authentication, this setting will be automatically set for you.

**Key:** Enter the key or passphrase to access a secure network.

**Show Hidden Key:** Check this box to display the key.

**Antenna:** Select to use the internal or external wireless antenna.

After making any changes, click the **Save Settings** button to save your changes, or click the **Don't Save Settings** button to discard your changes.

# Dynamic DNS

This section allows you to configure the DDNS setting for your camera. DDNS will allow all users to access your camera using a domain name instead of an IP address.

**DDNS:** Click to enable the DDNS function.

**Server Address:** Select your Dynamic DNS Server from the drop-down menu.

**Host Name:** Enter the host name of the DDNS server.

**User Name:** Enter your username or e-mail address used to connect to the DDNS.

**Password:** Enter your password used to connect to the DDNS server.

**Confirm Password:** Enter your password again for verification.

**Timeout:** You can setup how often the camera notifies the DDNS server of its current global IP address by entering a whole number in hours.

**Status:** Displays the connection status of your DDNS account.

The screenshot shows the D-Link camera's web interface. At the top, there's a navigation bar with 'D-Link' logo and tabs for 'LIVE VIDEO', 'SETUP', 'MAINTENANCE', 'STATUS', and 'HELP'. The 'SETUP' tab is active, and a sidebar on the left lists various setup options like 'Setup Wizard', 'Network', 'Wireless Setup', 'Dynamic DNS', etc. The main content area is titled 'DYNAMIC DNS' and contains an introductory paragraph explaining the feature. Below this are two buttons: 'Save Settings' and 'Don't Save Settings'. The second section is 'DYNAMIC DNS SETTING', which has a checked 'DDNS' checkbox. It includes fields for 'Server Address' (with a dropdown menu), 'Host Name', 'User Name', 'Password', 'Confirm Password', 'Timeout' (set to 576 hours), and 'Status' (set to Disabled). Another set of 'Save Settings' and 'Don't Save Settings' buttons is at the bottom. On the right side, there's a 'Helpful Hints..' section with additional information and a 'Status' section indicating the current DDNS status.

# Image Setup

This section allows you to adjust the image and sensor settings for your camera.

**Brightness:** This adjusts the brightness of the camera image.

**Saturation:** This adjusts the color saturation. Saturation controls the strength of color in the image.

**Contrast:** This adjusts the contrast of the camera image, making a dull image sharper or a bright image smoother.

**Hue:** The Hue controls the different degree of color stimulation in the camera image.

**Frequency:** This option adjusts the camera sensor's setting to avoid the image flickering under certain light sources, such as florescent lights. This is set to **Auto** by default.

**White Balance:** You can change the white balance of the camera image by selecting a setting from the drop-down box. This is set to **auto** by default.

**B/W:** Click this checkbox to change the camera image into black and white.

**Flip:** This will flip the image vertically.

**Mirror:** This will flip the image horizontally.

**Slow Shutter:** This can be used to allow manual control of the shutter speed. Select slower shutter speeds when environment is dimly lit, faster speeds are required when in brighter lighting.

**Note:** *Mirror and Flip* can be used if you have mounted the DCS-5222L on the ceiling.

The screenshot shows the D-Link web interface for the DCS-5222L camera. The main content area is titled "IMAGE SETUP" and contains a "LIVE VIDEO" window showing a camera feed of a chair. Below the video is the "IMAGE SETTINGS" section with the following controls:

Brightness	50	Saturation	50
Contrast	50	Hue	50
B/W	<input type="checkbox"/>	Mirror	<input type="checkbox"/>
Flip	<input type="checkbox"/>	Auto Exposure	<input checked="" type="checkbox"/>
Frequency	Auto	White Balance	Auto
Slow Shutter	Disable		

A "Reset to Default" button is located at the bottom of the settings section. The sidebar on the right contains "Helpful Hints..." with explanations for Brightness, Saturation, Contrast, Hue, and B/W.



# Audio and Video

You may configure four video profiles with different settings for your camera. You may also set up different profiles for your computer and mobile display. In addition, you may configure the audio (speakers and microphone) settings for your camera. There are three sensor output selections (VGA, XGA, and SXGA). Do not select SXGA if you want to turn on the motion detection feature.

**Video Profile:** This section allows you to change the **Encode Type, Resolution, FPS, and Quality.**

**Encode Type:** The compression format used when viewing your camera.

**Resolution:** Select the desired video resolution from the drop-down menu. The higher setting can obtain better quality. However, it will use more resource within your network.

**FPS:** Select the optimal setting depending on your network status. Please note that the higher setting can obtain better quality. However, it will use more resources within your network.

**bps:** Select the bitrate to assign the video. This is a constant bitrate. A higher bitrate will result in better looking video at the expense of a larger file size.

**Quality:** Select one of five levels of image quality: Highest, High, Medium, Low, and Lowest.

**RTSP URL:** The URL used to connect to the camera when viewing from QuickTime or a mobile device.

**Day/Night Mode:** Allows you to control the IR LEDs on the front of the camera. Note that when this option is enabled, live feed video will be in black and white, and ICR filter will be activated.

**Audio Setup:** Allows you to enable or disable and adjust the volume level of the speaker and microphone. If you select speaker, you must attach external speakers to the audio port on the camera.

**Note:** Video Profile 3 is always set to MJPEG as the Encode Type to ensure that at least one of the Video Profiles are viewable by non-IE browsers. Video Profile 4 is for mobile devices only, and always uses MPEG-4 as the Encode Type.

Product: DCS-5222L Firmware Version: 1.00

**D-Link**

DCS-5222L // LIVE VIDEO SETUP MAINTENANCE STATUS HELP

**AUDIO AND VIDEO**

You may configure audio and video settings (4 video profiles) here. Profile 3 has been set for snapshot, and profile 4 is set for your mobile phone or PDA device.

Save Settings Don't Save Settings

**VIDEO PROFILE 1**

Encode Type	Resolution	FPS	Encode Method	bps	RTSP URL
H.264	1280x720	30	CBR	4 Mbps	play1.sdp

**VIDEO PROFILE 2**

Encode Type	Resolution	FPS	Encode Method	bps	RTSP URL
H.264	640x352	10	CBR	1 Mbps	play2.sdp

**VIDEO PROFILE 3**

Encode Type	Resolution	FPS	Encode Method	Quality	RTSP URL
JPEG	320x176	10	Quality	Good	play3.sdp

**VIDEO PROFILE 4 (FOR MOBILE DEVICE ONLY)**

Encode Type	Resolution	FPS	Encode Method	bps	RTSP URL
H.264	320x176	10	CBR	384 Kbps	3gpp

**DAY/NIGHT MODE**

Day/Night Mode: Auto

**AUDIO SETUP**

Speaker  
Volume: 50

Microphone  
Volume: 50

Save Settings Don't Save Settings

**Helpful Hints.**

Higher Resolution, FPS and bps gives better video quality. At the same time, it requires more network bandwidth.

**Encode Type**  
Select the video codec 'JPEG', 'MPEG4', or 'H.264'.

**Resolution**  
The options depend on display system used.

**FPS**  
The amount of image frames rendered by the camera per second.

**bps**  
Select a fixed bandwidth for your camera operation. Higher value means a higher quality image but consumes more network bandwidth.

**Quality**  
Set the quality for image.

**RTSP URL**  
The URL used to connect to the camera when viewing from QuickTime or a mobile device.

**Day/Night Mode**  
Select night mode to use camera's IR LED in a dim light area.

**Speaker**  
When this option is

**Note:** Higher frame size, frame rate and bit rates will give you better video quality, but they will also require more network bandwidth. For best viewing results on a mobile phone, we suggest setting the frame rate to 5 fps and the bit rate to 20 Kbps.

After making any changes, click the **Save Settings** button to save your changes, or click the **Don't Save Settings** button to discard your changes.

# Time and Date

This section allows you to configure the settings of the internal system clocks for your camera.

**Time Zone:** Select the time zone for your region from the drop-down menu.

**Enable Daylight Saving:** Check this if the camera is in a region where daylight saving is observed.

**Auto Daylight Saving:** This option will adjust Daylight Saving Time automatically.

**Synchronize NTP Server:** Network Time Protocol will synchronize your camera with an Internet time server. You can enter an IP address of a server or select from the drop-down menu.

**Set the Date and Time Manually:** Select this to set the time manually.

**Copy your Computer's Time Settings:** Click to synchronize the time information from your PC.

The screenshot shows the D-Link camera web interface. The top navigation bar includes 'LIVE VIDEO', 'SETUP', 'MAINTENANCE', 'STATUS', and 'HELP'. The left sidebar lists various setup options, with 'Time and Date' selected. The main content area is titled 'TIME AND DATE' and contains the following configuration options:

- TIME AND DATE:** Here you may configure the internal clock of your camera. Includes 'Save Settings' and 'Don't Save Settings' buttons.
- TIME CONFIGURATION:**
  - Time Zone: (GMT-08:00) Pacific Time (US & Canada)
  - Enable Daylight Saving
    - Auto Daylight Saving
    - Set DST Manually
  - AUTOMATIC TIME CONFIGURATION:**
    - Synchronize with NTP Server
  - SET DATE AND TIME MANUALLY:**
    - Setup Date and Time Manually

At the bottom of the configuration area are 'Save Settings' and 'Don't Save Settings' buttons. The bottom of the page features the 'SURVEILLANCE' logo. A 'Helpful Hints..' sidebar on the right provides additional information: 'Setting the correct time and time zone will allow you to have accurate logs and proper scheduling for recordings.'

After making any changes, click the **Save Settings** button to save your changes, or click the **Don't Save Settings** button to discard your changes.

# Video Clip

Video Clip is a feature to send video clips via FTP or E-MAIL when a trigger is activated.

**Video Clip:** Check this box to enable the Video Clip function.

**Trigger By:** Select whether the event is triggered by **Motion**, **Schedule** or if the video is **Always** recording.

**Video Clip Type:** Displays the profile used for the recording and allows you to specify whether to start recording up to 5 seconds before the event to ensure the event is captured and the maximum duration of the video clip.

**Target:** Select where you want the video clip to be sent. It may be uploaded to an FTP or emailed to an email address.

You will need to enter your FTP or email server/account settings.

After making any changes, click the **Save Settings** button to save your changes, or click the **Don't Save Settings** button to discard your changes.

**D-Link**

DCS-5222L // LIVE VIDEO SETUP MAINTENANCE STATUS HELP

**VIDEO CLIP**

Video Clip is a feature to send video clips via FTP or E-Mail when a trigger is activated.  
(The target can't be select both FTP and E-mail for the video clip.)

Save Settings Don't Save Settings

**VIDEO CLIP**

Video Clip

Trigger by: Always

**Video Clip Type**

Source: Profile 2 (Configurable in Audio and Video)

Pre-event recording: 5 Seconds (Between 0 to 5 seconds)

Maximum duration: 10 Seconds (Between 5 to 10 seconds)

**Target**

FTP

FTP Server/Port: 21

User Name: \_\_\_\_\_

Password: \_\_\_\_\_

Path: \_\_\_\_\_

Filename Prefix: \_\_\_\_\_

Interval: 300 Seconds (Range : 60 to 86400 seconds)

Passive Mode:

E-mail

Save Settings Don't Save Settings

**Helpful Hints..**

Video Clip is the ability to store or send video clips to a remote E-mail or FTP server based on motion detection, external sensor input triggered.

**Trigger by Motion**  
Begin video clipping after a motion is detected.

**Schedule**  
Video clipping in a specified time.

**Always**  
Continuous video clipping.

**Digital Input**  
Begin video clip after digital input is detected.

**Video Clip Type**  
You can set video clip codec, Pre-event recording and Maximum duration here.

**Pre-event recording**  
Specify how much seconds of video will be recorded, before the video clip is taken.

**Maximum duration**  
Specify how much seconds of video clip.

**Target**  
You can select the target as FTP or E-mail for the video clip.

SURVEILLANCE

# Snapshot

Here, you can set the camera to take snapshots when motion is detected. Snapshots can be sent to an e-mail address or to an FTP server.

**Trigger by:** Select the trigger event from the drop-down menu. **Motion** begins a snapshot after a motion is detected; **Schedule** sends “snapshots” at a specified time; **Always** provides continuous snapshots.

**Snapshot Type:** Select whether to take a single snapshot or to take 6 snapshots with a 1 second interval between them.

**Target:** Select where you want the snapshot to be sent. It may be uploaded to an FTP or emailed to an email address.

You will need to enter your FTP or email server/account settings.

After making any changes, click the **Save Settings** button to save your changes, or click the **Don't Save Settings** button to discard your changes.

The screenshot shows the D-Link web interface for configuring snapshots. The main content area is titled "SNAPSHOT" and contains the following settings:

- Trigger by:** A dropdown menu set to "Always".
- Snapshot Type:** Radio buttons for "Single snapshot" and "6 snapshot with 1 second interval (3 frames before and 3 frames after motion frame)".
- Target:** Checkboxes for "FTP" and "E-mail".

At the bottom of the main content area, there are two buttons: "Save Settings" and "Don't Save Settings".

The sidebar on the right contains "Helpful Hints..." and "Trigger by Motion" information:

- Helpful Hints...:** Snapshot is the ability to store or send pictures to a remote E-mail or FTP server based on motion detection, external sensor input triggered.
- Trigger by Motion:** Begin snapshot after a motion is detected. Schedule Snapshot in a specified time.
- Always:** Continuous Snapshot. Digital Input Begin snapshot after digital input is detected.
- Snapshot Type:** You can set snapshot codec from Profile 3 (JPEG), Single snapshot or 6 snapshot here.
- 6 snapshot:** Select to take continuous 6 pictures for each snapshot.
- Target:** You can select the target as FTP or E-mail for the snapshot.

# SD Recording

This option allows you to configure and scheduling the recording of your camera. You can record video to the local SD Card.

**Enable** Check this checkbox to enable the recording feature. After enabling **recording**: recording, you will need to select a scheduling method.

**DS Card:** Select this option if you have inserted an available SD card into the camera.

**Trigger by:** Select the type of trigger event from the drop-down menu. **Motion** begins recording video/snapshot after a motion is detected; **Schedule** records video/takes snapshots at a specified time; **Always** will record video/take snapshots continuously.

**Recording Type:** Select to record video or take a snapshot.

**Recording Length:** Select the length of time for each video file.

**Keep Free Space:** This sets the capacity of your local SD Card to prevent the system from becoming unstable.

**Cyclic:** When this option is selected, it will cause the oldest file to be deleted when the system requires storage space for new files.

**D-Link**

DCS-5222L // LIVE VIDEO SETUP MAINTENANCE STATUS HELP

**SD RECORDING**

Here you may configure and schedule the recording of your camera. You must select the checkbox of 'SD Recording' to turn on the feature.

Save Settings Don't Save Settings

**SD RECORDING**

SD Recording

Trigger by: Always

**Recording Type**

Snapshot

Video

Source: Profile 2 (Configurable in [Audio and Video](#))

Recording Length: 1 minutes per file

**SD Card**

Keep Free Space: 200 MB (Minimum is 200)

Cyclic

Save Settings Don't Save Settings

**Helpful Hints...**

SD Recording is the ability to record video or snapshot (per second) to local SD Card based on motion detection or in a specified time.

**Trigger by**  
**Motion**: Begin SD recording after a motion is detected.  
**Schedule**: SD recording in a specified time.  
**Always**: Continuous SD recording.  
**Digital Input**: Begin recording after digital input is detected.

**Recording Type**  
 You can set recording mode, set pre-event recording, and post-event recording here when Trigger by is Motion. You can also select recording as Snapshot or Video.

**Recording Length**  
 Set the time length of

After making any changes, click the **Save Settings** button to save your changes, or click the **Don't Save Settings** button to discard your changes.

# Digital Output

You can enable the digital output port as well as configure a trigger event.

**Motion Detection:** When a motion detection is triggered.

**D/I Signal:** A trigger from the Digital Input port.

The screenshot shows the D-Link web interface for the DCS-5222L camera. The top navigation bar includes 'LIVE VIDEO', 'SETUP', 'MAINTENANCE', 'STATUS', and 'HELP'. The left sidebar lists various configuration options, with 'Digital Output' selected. The main content area is titled 'DIGITAL OUTPUT' and contains the following text and controls:

Here you can enable your D/O port as well as how the event will be triggered.

Save Settings    Don't Save Settings

**DIGITAL OUTPUT**

D/O Signal

Trigger Event:

Only during

Day:  Sun  Mon  Tue  Wed  Thu  Fri  Sat

Time: Start  :  End  :

Save Settings    Don't Save Settings

Helpful Hints..

You may choose a trigger event like Motion detection or triggers from the D/I port. When an event is triggered, the D/O will begin sending a signal.

SURUEILLANCE

# Motion Detection

This option allows you to set up Motion Detection on your network camera. In order to use motion detection, first check the **Enable Video Motion** checkbox. Next, click on the video window and draw motion detection zones by clicking and dragging the mouse cursor. Red areas indicate areas that will be monitored for motion. The camera also has a PIR sensor which is used to detect motion using a special infrared sensor. PIR is good at detecting motion from live subjects such as people and animals.

**Enable Video Motion:** Check this box to enable the motion detection feature of your camera.

**Enable PIR:** When this option is selected, use PIR (passive infrared) to detect motion.

**Sensitivity:** This setting adjusts how sensitive the camera will be to motion, where 100% will be the most sensitive setting and 0% will be the least sensitive setting.

**Drawing Mode:** Select **Draw Motion Area** to select the area of the picture to monitor for movement to trigger recording or snapshot. Use your mouse to click on the blocks that you would like to monitor for motion. Select **Erase Motion Area** to remove the blocks and stop the camera from monitoring that area of the picture.

**Clear:** Clicking this button will clear all motion detection zones.

After making any changes, click the **Save Settings** button to save your changes, or click the **Don't Save Settings** button to discard your changes.

**Note:** If the camera is set to SXGA mode in Audio and Video, Motion Detection is disabled.

The red grid on the right indicates an area that has been selected for motion detection. When motion is detected, the LIVE VIDEO page will display a blinking orange motion video icon like the one below.



The motion notification will continue to blink as long as motion is detected. If no additional motion is detected, it will return to its original state after eight seconds.

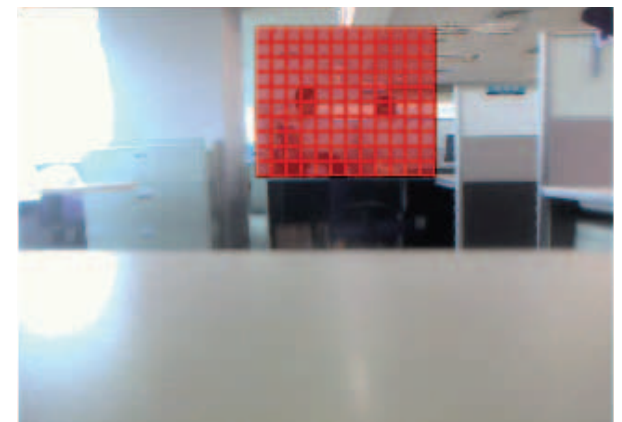



# Camera Control

Select the **Preset Position** from the drop-down menu to access settings that affect how the Internet Camera can pan and move to preset locations.

**Set As Home:** Click to set the current position as Home.

**Default Home:** Click to set the Home position with the default setting.

**Pan Step:** Select the speed at which the camera will pan for a full cycle from the drop-down list. Select a value between 0 and 10, 0 being the slowest setting.

**Tilt Step:** Select the speed at which the camera will tilt for a full cycle from the drop-down menu. Select a value between 0 and 10, 0 being the slowest.

**Preset Name:** Enter a name for your camera location and click **Add**.

**Present Position:** Select created presets from the drop-down menu. If you want to delete an entry, select it and then click **Delete**.

**Patrol Selection:** To use the Auto Patrol feature, select the desired preset positions from the *Preset Locations* list and add them to the *Patrol Positions* list by clicking **Select**. You can then select the order in which the camera will patrol through the preset locations by selecting a location and clicking **Up** or **Down**. Click **Remove** to remove a location from the list. Click **Save** when finished.

The screenshot displays the D-Link web interface for the DCS-5222L camera. The main content area is titled "CAMERA CONTROL" and contains the following sections:

- PRESET POSITION:** Includes a live video feed showing a jacket on a chair. To the right is a directional pad. Below the pad are buttons for "Home Definition" (Set As Home, Default Home), "Pan Step" (set to 10), and "Tilt Step" (set to 10). Below these are input fields for "Preset Name" and "Preset Position" (with a dropdown menu), and buttons for "Add" and "Delete".
- PATROL SELECTION:** Features two empty lists: "Preset Positions" and "Patrol Positions". A "Select" button is positioned between the lists. Below the lists are "Up", "Down", and "Remove" buttons. A "Dwelling Time" field is set to 1 second, with a "Save" button below it.

The interface also includes a navigation menu on the left (Setup Wizard, Network, Wireless Setup, Dynamic DNS, Image Setup, Audio and Video, Time and Date, Video Clip, Snapshot, SD Recording, Digital Output, Motion Detection, Camera Control, SD Management, Logout) and a "Helpful Hints" sidebar on the right with sections for Home Definition, Patrol Selection, Patrol Positions, and Dwelling Time.

# SD Management

This page allows you to browse and manage the recorded files on an SD card which is inserted into the camera.

**Format SD Card:** Click to automatically format the SD Card and create folder for video. Formatting your SD Card will erase all data currently saved.

**Delete:** Click the checkbox in front of the Delete button to select all the files and catalogs below. The Delete button is used to delete the files or catalogs which are selected.

**Name:** The name of file or catalog.

**Size:** The file's size.

**Refresh:** Click to refresh the page.

**Files per page:** Select the number of files to be displayed on a single page. The maximum is 100 files.

**Pages:** Show the current and total pages.

The screenshot shows the D-Link web interface for SD Management. The top navigation bar includes 'LIVE VIDEO', 'SETUP', 'MAINTENANCE', 'STATUS', and 'HELP'. The left sidebar lists various setup options like 'Setup Wizard', 'Network', 'Wireless Setup', etc. The main content area is titled 'SD MANAGEMENT' and contains the following information:

- SD Card: DCS-5222L /
- SD Status: Ready
- Files per Page: 5 (with a 'Refresh' link)
- Pages: 1 of 1
- A table with columns for 'Name' and 'Size'. One file is listed: '20110101'.
- A 'Format SD Card' button.
- Total storage: 4026752 KB, Used: 4864 KB, Free: 4021888 KB.

The right sidebar contains 'Helpful Hints..' with instructions: 'Format SD Card Click this button to automatically format the SD Card and create folder for snapshot and video.'

# Maintenance Admin

This section allows you to change the administrator's password and configure the server settings for your camera. You can also manage the user account(s) that access to your camera.

**Admin Password Setting:** This section lets you change the admin password used to log into the camera and change settings. After installing the camera for the first time, it is highly recommended that you change the admin password for security purposes.

Enter the existing password, then enter your old new password. Click **Save** to apply your new settings.

**Add User Account:** You may create user accounts to allow others to log into your camera to view the live camera feed. Users cannot change any settings.

Enter the User Name you wish to use for the new user account and then create a password for that account. Click Add to save your account.

**User List:** Select a user from the drop-down menu and click **Delete** to remove the user account from having access to the camera images.

**RTSP Authentication:** Check to enable RTSP streaming.

**HTTP Authentication:** Check to enable HTTP streaming.

**Snapshot URL Authentication:** Select **Enable** to allow access to the current camera snapshot via the web address indicated.

**D-Link**

DCS-5222L // LIVE VIDEO SETUP MAINTENANCE STATUS HELP

Admin

System

Firmware Upgrade

Logout

**ADMIN**

Here you can change the administrator's password for your account as well as add and/or delete user account(s). You can also configure a unique name for your camera, and enable its OSD (On-Screen Display) feature in order to display camera name and time stamp for both live video and recordings of your camera.

**ADMIN PASSWORD SETTING**

Old Password  30 characters maximum

New Password  30 characters maximum

Confirm New Password

**ADD USER ACCOUNT**

User Name  30 characters maximum

New Password  30 characters maximum

Confirm New Password

20 users maximum

**USER LIST**

User Name  -- User list --

**AUTHENTICATION**

RTSP Authentication

HTTP Authentication

Snapshot URL Authentication (<http://192.168.0.101/image/jpeg.cgi>)

**DEVICE SETTING**

Camera Name  30 characters maximum

OSD

Label  30 characters maximum

Time Stamp

Power/Link LED Light

**PRIVACY CONTROL**

Privacy Control

Privacy Off

Privacy On

**Helpful Hints...**

For security purposes, it is recommended to change the password for your administrator account. Be sure to write down the new password to avoid having to reset the camera in the event that it is forgotten.

**User Account**  
User account is given to an user a privilege to login into Live View page and use functions in the page.

**RTSP Authentication**  
Enable user validation for RTSP streaming.

**HTTP Authentication**  
Enable user validation for HTTP streaming.

**Snapshot URL Authentication**  
Enable user validation for Snapshot URL.

**OSD**  
Enable OSD, the Label and Time Stamp will be displayed on the Live Video Image.

**Power/Link LED Light**  
**On**  
Normal LED blinking depending on power and linkage status.  
**Off**  
Always turn off LED.  
**Flicker**  
Always flicking Link LED as video being monitored.

**Privacy Control**  
Allow you to configure if camera could enter Privacy mode or not.  
**Privacy Off**  
Camera is in a normal operating mode.  
**Privacy On**  
Camera is in a Privacy mode. Live Video/Audio will be turned off.

**SURVEILLANCE**

**Camera Name:** Enter the name of your camera. This is useful if you have multiple cameras.

**Enable OSD:** This will enable the information bar On Screen Display (OSD) to appear when viewing video.

**Label:** This is the text label that will appear on the OSD.

**Time Stamp:** If checked, the current time will be displayed on the OSD.

**LED Light:** This will turn the camera's front LED indicator on or off.

**Calibrate the Device:** Clicking this button will calibrate the camera so that the P/T/Z apparatus functions correctly. The camera is automatically calibrated whenever it is powered on and initialized or reset. Should the camera's pan, tilt, and zoom functions begin to behave incorrectly, or if the device has been jarred or handled improperly, you may need to recalibrate the camera manually by pressing this button.

**Privacy Mode:** Select on/off or schedule the privacy mode for your camera to ensure the privacy. When the privacy mode is turned on, the camera hides the lens by rolling it back into the unit.

After making any changes, click the **Save** button to save your changes.

# System

This screen allows you to save and restore the camera's current configuration. You can also reset all settings to factory default or reboot the device.

**Save to Local Hard Drive:** Click on the **Save Configuration** button to save the current configuration to your hard drive.

**Load from Local Hard Drive:** To load a saved configuration, click on the **Browse Hard Drive:** button to select a configuration file from your hard drive. Then, click the **Load Configuration** button to load the new configuration.

**Restore to Factory Defaults:** Click this button to reset all settings to their factory defaults. If you select to reset your settings, you will need to set up your camera again.

**Reboot Device:** Clicking the **Reboot** button will reboot your device.

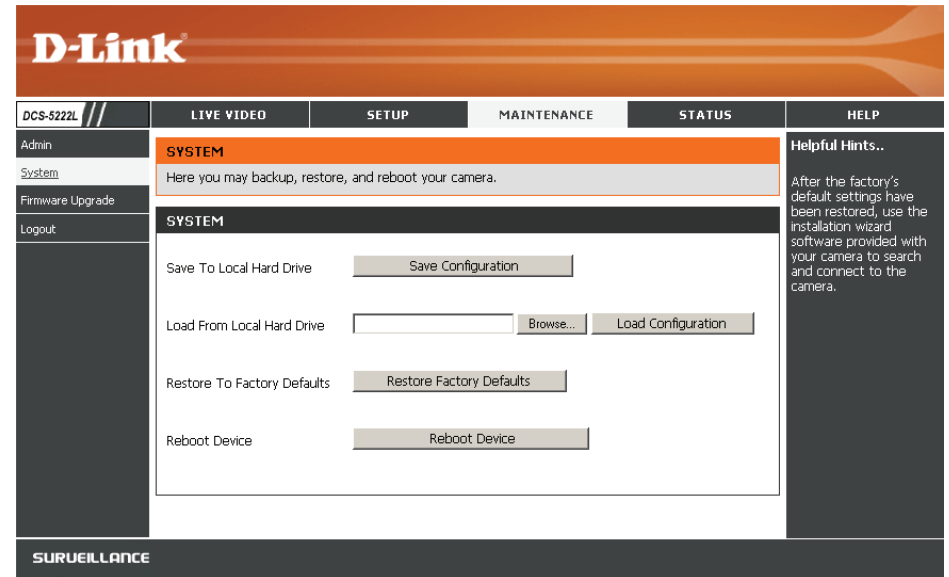

# Firmware Upgrade

Your current firmware version and date will be displayed on this page. You can also upgrade your firmware with a new version.

To upgrade your firmware, go to **support.dlink.com** and download the latest firmware to your computer's hard drive. Click on **Browse**, select the firmware file, then click the **Upload** button. While the firmware is being upgraded, do not turn off your computer or camera, and do not disconnect your network connection from your computer or camera. Upgrading the firmware will not change any of your system settings, but it is recommended that you save your system configuration before doing a firmware upgrade.

**Note:** *It is recommended that you use a wired connection for your computer and camera when upgrading the firmware.*

The screenshot displays the D-Link web interface for a DCS-5222L camera. The top navigation bar includes 'LIVE VIDEO', 'SETUP', 'MAINTENANCE', 'STATUS', and 'HELP'. The left sidebar menu has 'Admin', 'System', 'Firmware Upgrade' (selected), and 'Logout'. The main content area features a 'FIRMWARE UPGRADE' section with the following text:

A new firmware upgrade may be available for your IP camera. It is recommended to keep your IP camera firmware up-to-date to maintain and improve the functionality and performance of your internet camera. Click here [D-Link Support Page](#) to check for the latest firmware version availability. To upgrade the firmware on your IP camera, please download and save the latest firmware version from the D-Link Support Page to your local hard drive. Locate the file on your local hard drive by clicking the Browse button. Once you have found and opened the file using the browse button, click the "Upload" button to start the firmware upgrade.

Below this is a 'FIRMWARE INFORMATION' table:

FIRMWARE INFORMATION	
Current Firmware Version:	1.00
Current Firmware Build Number:	0928

At the bottom of the main content area is another 'FIRMWARE UPGRADE' section with a 'File Path:' input field, a 'Browse...' button, and an 'Upload' button.

The right sidebar contains 'Helpful Hints...' with text explaining that firmware upgrades are released periodically to improve functionality and add new features, and provides a link to check for updates.

# Status

## Device Info

This screen displays various information about your camera and its current settings.

The screenshot shows the D-Link web interface for the DCS-5222L camera. The top navigation bar includes 'LIVE VIDEO', 'SETUP', 'MAINTENANCE', 'STATUS', and 'HELP'. The 'STATUS' tab is selected, and the 'Device Info' sub-tab is active. The main content area is titled 'DEVICE INFO' and contains a message: 'All of your network connection details are displayed on this page. The firmware version is also displayed here.' Below this is an 'INFORMATION' section with the following details:

Camera Name	DCS-5222L
Time & Date	Sat Jan 1 00:34:56 2011
Firmware Version	1.00
Firmware Build Number	0928
MAC Address	5C:33:8E:43:B3:1B
IPv4 Address	192.168.0.101
IPv4 Subnet Mask	255.255.255.0
IPv4 Default Gateway	192.168.0.1
IPv4 Primary DNS	192.168.0.1
IPv4 Secondary DNS	
PPPoE Status	Disabled
DDNS Status	Disabled

On the right side, there is a 'Helpful Hints..' section with the text: 'This page displays all the information about the camera and network settings.' The bottom of the interface features a 'SURVEILLANCE' banner.

# Log

The log shows you a list of events that have happened recently. You can download the log by clicking the **Download** button, or you can empty the log by clicking the **Clear** button.

The screenshot shows the D-Link web interface for the DCS-5222L camera. The top navigation bar includes 'LIVE VIDEO', 'SETUP', 'MAINTENANCE', 'STATUS', and 'HELP'. The 'Log' page is active, showing a 'SYSTEM LOG' section with a description: 'The system log records camera events that have occurred.' Below this is the 'CURRENT LOG' section, which contains a list of events:

```

2011-01-01 00:27:39 admin is streaming video.
2011-01-01 00:27:42 admin is streaming video.
2011-01-01 02:01:43 admin is streaming video.
2011-01-01 02:05:44 admin is streaming video.
2011-01-01 02:19:40 admin is streaming video.
2011-01-01 02:19:40 admin is streaming video.
2011-01-01 02:22:00 admin is streaming video.
2011-01-01 06:43:18 admin is streaming video.
2011-01-01 06:44:39 admin is streaming video.
2011-01-01 06:48:12 admin is streaming video.
2011-01-01 06:49:25 admin is streaming video.
2011-01-01 06:51:56 admin is streaming video.
2011-01-01 06:56:08 admin is streaming video.
2011-01-01 06:59:57 admin is streaming video.
2011-01-01 07:01:00 admin is streaming video.
2011-01-01 07:02:27 admin is streaming video.
2011-01-01 07:03:16 admin is streaming video.
2011-01-01 07:03:49 admin is streaming video.
2011-01-01 07:04:33 admin is streaming video.
2011-01-01 07:07:59 admin is streaming video.
2011-01-01 07:09:32 admin is streaming video.
2011-01-01 07:13:48 admin is streaming video.
2011-01-01 07:15:40 admin is streaming video.
2011-01-01 07:18:22 admin is streaming video.
2011-01-01 07:20:48 admin is streaming video.
2011-01-01 07:25:01 admin is streaming video.
2011-01-01 07:27:00 Recording 20110101_072652.avi at 2011/01/01 07:26:52 to SD Card is OK.
2011-01-01 07:27:17 admin is streaming video.
2011-01-01 07:28:16 admin is streaming video.
  
```

At the bottom of the log list, there are two buttons: 'Clear' and 'Download'. The 'Helpful Hints..' section on the right side of the page provides instructions: 'You can save the log to your local hard drive by clicking the Download button, and you can clear the log by clicking on the Clear button.'



# Help

The screenshot displays the D-Link web interface for the DCS-5222L camera. At the top, the D-Link logo is visible on an orange background. Below the logo is a navigation bar with tabs for LIVE VIDEO, SETUP, MAINTENANCE, STATUS, and HELP. The HELP tab is currently selected. On the left side, there is a vertical menu with options: Help Menu, Acknowledgements, and Logout. The main content area is divided into sections: HELP MENU (with links to LIVE VIDEO, SETUP, MAINTENANCE, and STATUS), LIVE VIDEO (with a link to Camera), SETUP (with links to Setup Wizard, Network, Wireless Setup, Dynamic DNS, Image Setup, Audio and Video, Time and Date, Video Clip, Snapshot, SD Recording, Digital Output, Motion Detection, Camera Control, and SD Management), MAINTENANCE (with links to Admin, System, and Firmware Upgrade), and STATUS (with links to Device Info and Log). At the bottom of the page, the word SURVEILLANCE is displayed.

DCS-5222L //		LIVE VIDEO	SETUP	MAINTENANCE	STATUS	HELP
Help Menu	<b>HELP MENU</b>					
Acknowledgements	LIVE VIDEO					
Logout	SETUP					
	MAINTENANCE					
	STATUS					
<b>SURVEILLANCE</b>						

## Configuring the DCS-5222L with a Router

D-Link's DCS-5222L is a versatile and cost effective Network Camera offering both video and audio monitoring. It can also serve as a powerful surveillance system in security applications. The DCS-5222L can be used with any wired or 802.11n/g wireless router. This section explains how to view the camera from either the Internet or from inside your internal network.

Components Needed:

- 1 DCS-5222L Network Camera
- 1 Ethernet Cable
- A wired or wireless router such as the D-Link DIR-655 Wireless Router
- Ethernet-based PC for system configuration

### Setting up the DCS-5222L for Use Behind a Router

Installing a DCS-5222L Network Camera on your network is an easy 4–step procedure:

1. Assign a local IP address to your network camera.
2. View the network camera using your Internet Explorer web browser.
3. Access the router with your web browser.
4. Open virtual server ports to enable remote image viewing.

**Note:** *These are manual steps; however, if you decide to use the wizard, it will perform every step automatically.*

This section is designed to walk you through the setup process for installing your camera behind a router and enable remote video viewing. For the basic setup of the DCS-5222L, follow the steps outlined in the Quick Installation Guide.

After you have completed the setup of the DCS-5222L outlined in the Quick Installation Guide you will have an operating camera that has an assigned IP Address. Because you are using a router to share the Internet with one or more PCs, the IP Address assigned to the Network Camera will be a local IP Address. This allows viewing within your Local Area Network (LAN) until the router is configured to allow remote viewing of the camera over the Internet.

## 1. Assign a Local IP Address to Your Camera

Run the setup wizard from the CD included with the DCS-5222L. Follow the steps in the Quick Installation Guide to configure the DCS-5222L. The camera will be assigned a local IP Address that allows it to be recognized by the router. Write down this IP Address for future reference.

## 2. View the Network Camera Using Your Internet Explorer Web Browser

Open a Web browser. In the address bar, type in the IP Address that was assigned to the Network Camera. The DCS-5222L Live Video Page appears with a window displaying live video from the camera.

Click on the **Setup** button on the left side. Scroll to the bottom of the Network Setup page to display the ports used by HTTP and Streaming audio and video.

The screenshot displays the web interface for a D-Link DIR-655 router. The left sidebar contains navigation options: LEVEL INFO, LOGS, STATISTICS, INTERNET SESSIONS, WIRELESS, and WISH SESSIONS. The main content area is titled 'DEVICE INFORMATION' and is divided into several sections:

- GENERAL:** Shows the current time as 2007/10/10 PM 10:10:33 and the firmware version as 1.02, 2006/10/13.
- WAN:** Displays connection details for the WAN interface, including:
  - Connection Type: DHCP Client
  - QoS Engine: Active
  - Cable Status: connected
  - Network Status: connected
  - Connection Up Time: N/A
  - MAC Address: 00:19:5B:03:04:E9
  - IP Address: 210.21.33.48
  - Subnet Mask: 255.255.255.248
  - Default Gateway: 210.21.33.254
  - Primary DNS Server: 168.95.1.1
  - Secondary DNS Server: 0.0.0.0
- LAN:** Displays details for the LAN interface:
  - MAC Address: 00:19:5B:03:04:E9
  - IP Address: 192.168.0.1
  - Subnet Mask: 255.255.255.0
  - DHCP Server: Enabled
- WIRELESS LAN:** Shows wireless settings:
  - Wireless Radio: Enabled
  - WISH: Active
  - MAC Address: 00:19:5B:03:04:E9
  - Network Name (SSID): dlink
  - Channel: 4
  - Security Mode: Disabled
  - WiFi Protected Setup: Enabled/Not Configured
- LAN COMPUTERS:** A table listing connected devices:
 

IP Address	Name (if any)	MAC
192.168.0.155	end_user	00:05:5d:ce:b3:8d
- IGMP MULTICAST MEMBERSHIPS:** Shows a Multicast Group Address of 229.255.255.250.

The **Setup > Network** page displays the port settings for your camera. If necessary, these ports can be changed if they are already in use by other devices (e.g. in a multiple camera environment).

**Note:** Both the HTTP port and RTSP port are required to be opened for the DCS-5222L.

The screenshot displays the D-Link web interface for the DCS-5222L camera. The top navigation bar includes 'DCS-5222L', 'LIVE VIDEO', 'SETUP', 'MAINTENANCE', and 'STATUS'. A sidebar on the left lists various configuration options, with 'Network' selected. The main content area is titled 'NETWORK' and contains the following sections:

- NETWORK**: A message stating 'You can configure your LAN and Internet settings here.' with 'Save Settings' and 'Don't Save Settings' buttons.
- LAN SETTINGS**:
  - LAN SETTINGS**:
    - Automatic IP Address
    - Static IP Address
    - PPPoE
  - PORT SETTINGS**:
    - HTTP Port: 80
    - RTSP Port: 554
  - UPnP**:
    - UPnP
    - UPnP Port Forward
  - Apple**:
    - Bonjour

The bottom of the interface features a 'SURVEILLANCE' banner.

## Router Set-Up and Installation

The following steps generally apply to any router that you have on your network. The D-Link DIR-655 is used as an example to clarify the configuration process. Refer to the router's user manual for more information on router operation and configuration.

### 3. Access the Router with Your Web Browser

If you have cable or DSL Internet service, you will most likely have a dynamically assigned WAN IP Address. 'Dynamic' means that your router's WAN IP address can change from time to time depending on your ISP. A dynamic WAN IP Address identifies your router on the public network and allows it to access the Internet. To find out what your router's WAN IP Address is, go to the Status page on your router and locate the WAN information for your router (as shown on the next page). The WAN IP Address will be listed. This will be the address that you will need to type in your web browser to view your camera over the Internet.

Your WAN IP Address will be listed on the router's **Status > Device Info** page.

The screenshot shows the web interface for a D-Link DIR-655 router. The top navigation bar includes tabs for SETUP, ADVANCED, TOOLS, STATUS, and SUPPORT. The left sidebar contains menu items: DEVICE INFO, LOGS, STATISTICS, INTERNET SESSIONS, WIRELESS, and WEB SESSIONS. The main content area is titled 'DEVICE INFORMATION' and contains the following sections:

- GENERAL:** Time: 2007/10/10 PM 10:10:33, Firmware Version: 1.02, 2006/10/13
- WAN:** Connection Type: DHCP Client, QoS Engine: Active, Cable Status: connected, Network Status: connected, Connection Up Time: N/A, MAC Address: 00:19:5B:03:04:E9, IP Address: 210.21.33.48, Subnet Mask: 255.255.255.248, Default Gateway: 210.21.33.254, Primary DNS Server: 168.95.1.1, Secondary DNS Server: 0.0.0.0
- LAN:** MAC Address: 00:19:5B:03:04:E9, IP Address: 192.168.0.1, Subnet Mask: 255.255.255.0, DHCP Server: Enabled
- WIRELESS LAN:** Wireless Radio: Enabled, WISP: Active, MAC Address: 00:19:5B:03:04:E9, Network Name (SSID): dlink, Channel: 4, Security Mode: Disabled, WPA Protected Setup: Enabled/Not Configured
- LAN COMPUTERS:** A table with columns for IP Address, Name (if any), and MAC. One entry is shown: IP Address: 192.168.0.155, Name: end\_user, MAC: 00:05:5d:ceb3:0d
- IGMP MULTICAST MEMBERSHIPS:** Multicast Group Address: 239.255.255.250

Helpful Hints... All of your WAN and LAN connection details are displayed here. More...

**Note:** Because a dynamic WAN IP can change from time to time depending on your ISP, you may want to obtain a Static IP address from your ISP. A Static IP address is a fixed IP address that will not change over time and will be more convenient for you to use to access your camera from a remote location. The Static IP Address will also allow you to access your camera attached to your router over the Internet.

### 4. Open Ports to Enable Remote Image Viewing (Port Forwarding)

The firewall security features built into the DIR-655 router prevent users from accessing the video from the DCS-5222L over the Internet. The router connects to the Internet over a series of numbered ports. The ports normally used by the DCS-5222L are blocked from access over the Internet. Therefore, these ports need to be made accessible over the Internet. This is accomplished using the Virtual Server function on the DIR-655 router. The Virtual Server ports used by the camera must be opened through the router for remote access to your camera. Virtual Server is accessed by clicking on the **Advanced** tab of the router screen.

Follow these steps to configure your router's Virtual Server settings:

1. Click **Enabled**.
2. Enter a different name for each entry.
3. Enter your camera's local IP Address (e.g., 192.168.0.120) in the Private IP field.
4. Select TCP for HTTP port, both (TCP and UDP) for RTSP and both (TCP and UDP) for 5556 - 5559 ports.
5. If you are using the default camera port settings, enter 80 into the Public and Private Port section, click **Apply**.
6. Scheduling should be set to Always so that the camera images can be accessed at any time.

Repeat the previous steps adding the port 554 to both the Public and Private Port sections. A check mark appearing before the entry name will indicate that the ports are enabled.

Important: Some ISPs block access to port 80 and other commonly used Internet ports to conserve bandwidth. Check with your ISP so that you can open the appropriate ports accordingly. If your ISP does not pass traffic on port 80, you will need to change the port the camera uses from 80 to something else, such as 800. Not all routers are the same, so refer to your user manual for specific instructions on how to open ports.

Enter valid ports in the Virtual Server section of your router. Please make sure to check the box next to the camera name on the Virtual Server List to enable your settings.

**D-Link**

DIR-655 // SETUP ADVANCED TOOLS STATUS SUPPORT

**VIRTUAL SERVER**

The Virtual Server option allows you to define a single public port on your router for redirection to an internal LAN IP Address and Private LAN port if required. This feature is useful for hosting online services such as FTP or Web Servers.

Save Settings Don't Save Settings

**24--VIRTUAL SERVERS LIST**

	Name	IP Address	Port	Traffic Type	Schedule	Inbound Filter
<input checked="" type="checkbox"/>	DCS-942L	192.168.0.120	80	TCP	Always	Allow All
<input checked="" type="checkbox"/>	DCS-942L	192.168.0.120	554	TCP	Always	Allow All
<input type="checkbox"/>		0.0.0.0	0	TCP	Always	Allow All

**Helpful Hints...**

Check the **Application Name** drop down menu for a list of predefined server types. If you select one of the predefined server types, click the arrow button next to the drop down menu to fill out the corresponding field.

You can select a computer from the list of DHCP clients in the **Computer Name** drop down menu, or you can manually enter the IP address of the computer at which you would like to open the specified port.

Select a schedule for when the virtual server will be enabled. If you do not see the schedule you need in

# Troubleshooting

This chapter provides solutions to problems that can occur during the installation and operation of the DCS-5222L.

## 1. What is Remote Access? How do I enable it?

Remote Access allows you to access your camera from any PC connected to the Internet through a web browser. This lets you view your camera feed and manage your camera's settings when you're away from home.

To enable Remote Access, simply go through the Camera Installation Wizard included on the Installation CD that came in your package. You can also download the wizard from <http://www.mydlink.com/support>.

After going through the wizard, you should see Remote Status: Enabled on the summary page. If you see Remote Status: Disabled, make sure that:

- ...the front LED on your camera is lit solid green
- ...your Internet connection is working
- ...your router's LAN & WAN connections are working properly
- ...your router has UPnP enabled (if your router does not support UPnP, please refer to Appendix A)
- ...your router can get a public IP
- ...your router is upgraded to the latest firmware
- ...you have tried rebooting your router by unplugging it, then plugging it back in

After checking the above items, you can click the Retry button to refresh the summary screen to see if Remote Access has been enabled.

## 2. What can I do if I forget my password?

If you forget your password, you will need to perform a hard reset of your camera. This process will change all your settings back to the factory defaults. To reset your camera, please use an unfolded paperclip to press and hold the RESET button for at least 8 seconds while your camera is plugged in.



### **3. In addition to using mydlink.com, is there another way to access my camera remotely over the Internet?**

Yes, you can access your camera over the Internet through the following URL after successfully installing your camera through the Camera Installation Wizard:

`http://mydlinkNo.eu.mydlink.com.`

For example, if your camera's mydlink No. was 12345678, you would be able to access your camera remotely by opening your web browser and going to `http://12345678.eu.mydlink.com.`

This URL will open a webpage where you will be asked to log in by entering your camera's password. After entering your password, your camera's Live View window will open, and you will be able to configure your camera as well.

### **4. Why does the LED not light up?**

The power supply might be faulty. Confirm that you are using the provided DC 5V power supply for this network camera. Verify that the power supply is correctly connected. If the camera is functioning normally, the LED may have been disabled.

### **5. Why is the camera's network connection unreliable?**

There might be a problem with the network cable. To confirm that the cables are working, PING the address of a known device on the network. If the cabling is OK and your network is reachable, you should receive a reply similar to the following (...bytes = 32 time = 2 ms).

Another possible problem may be that the network device such as a hub or switch utilized by the Network Camera is not functioning properly. Please confirm the power for the devices are well connected and functioning properly.

### **6. Why does the Network Camera work locally but not remotely?**

This might be caused by the firewall protection. Check the Internet firewall with your system administrator. The firewall may need to have some settings changed in order for the Network Camera to be accessible outside your local LAN. For more information, please refer to the section about installing your camera behind a router.

Make sure that the Network Camera isn't conflicting with any Web server you may have running on your network. The default router setting might be a possible reason. Check that the configuration of the router settings allow the Network Camera to be accessed outside your local LAN.

### **7. Why does a series of broad vertical white lines appear through out the image?**

It could be that the CMOS sensor (a square panel situated behind the lens that measures the light signals and changes it into a digital format so your computer can present it into an image that you are familiar with) has become overloaded when it has been exposed to bright lights such as direct exposure to sunlight or halogen lights. Reposition the Network Camera into a more shaded area immediately as prolonged exposure to bright lights will damage the CMOS sensor.

### **8. The camera is producing noisy images. How can I solve the problem?**

The video images might be noisy if the Network Camera is used in a very low light environment.

### **9. The images are poor quality, how can I improve the image quality?**

Make sure that your computer's display properties are set to at least 6-bit color. Using 16 or 256 colors on your computer will produce dithering artifacts in the image, making the image look as if it is of poor quality.

The configuration on the Network Camera image display is incorrect. The Web Configuration Video section of the Web management allows you to adjust the related-parameters for improved images such as: brightness, contrast, hue and light frequency. Please refer to the Web Configuration section for detailed information.

### **10. Why are no images available through the Web browser?**

ActiveX might be disabled. If you are viewing the images from Internet Explorer make sure ActiveX has been enabled in the Internet Options menu. You may also need to change the security settings on your browser to allow the ActiveX plug-in to be installed.

If you are using Internet Explorer with a version number lower than 6, then you will need to upgrade your Web browser software in order to view the streaming video transmitted by the Network Camera.

### **11. The PIR is no operation well, how can I improve the PIR quality?**

- For the Passive Infrared Sensor (PIR) to function properly it is required to have direct line of site to the object. When the room has many obstacles or the line of site is obstructed by glass, the PIR will not function properly.
- When the environment temperature is too high, the PIR detection will slow down and should not be mistaken for a faulty PIR.
- This Network Camera can only be installed indoors. Do not install this camera in a place where IR interference can be a problem. IR interference can be found close to glass doors or windows, where direct sunlight can cause interference or in the path of car headlights.

- Do not install this camera next to or in front of an air conditioner outlet or vent.
- Do not install this camera close to wireless devices with high frequencies as the PIR is easily affected by RF radiation.
- The PIR functions at best when detecting lateral movements. Radial movements cannot be detected as well as lateral movements.
- Do not install this camera directly under an extreme bright light. The PIR cannot fully suppress a bright white light.
- Any movements from an object with a normal body temperature, like humans or animals, can be detected. To avoid any malfunctions, install this camera at the proper height.
- To avoid any malfunctions, install this camera in an environment with an average temperature of 25°C. Only within a distance of 2.5 meters can smaller movements of an object, with the average adult human's height, be detected. Between a distance of 2.5 and 5 meters, a larger movement of an object is required for detection.
- Install this camera on a firm, static, anti-shock surface.

# Networking Basics

## Check your IP address

After you install your new D-Link adapter, by default, the TCP/IP settings should be set to obtain an IP address from a DHCP server (i.e. wireless router) automatically. To verify your IP address, please follow the steps below.

Click on **Start > Run**. In the run box type **cmd** and click **OK**. (Windows® 7/Vista® users type cmd in the Start Search box)

At the prompt, type **ipconfig** and press **Enter**.

This will display the IP address, subnet mask, and the default gateway of your adapter.

If the address is 0.0.0.0, check your adapter installation, security settings, and the settings on your router. Some firewall software programs may block a DHCP request on newly installed adapters.

If you are connecting to a wireless network at a hotspot (e.g. hotel, coffee shop, airport), please contact an employee or administrator to verify their wireless network settings.

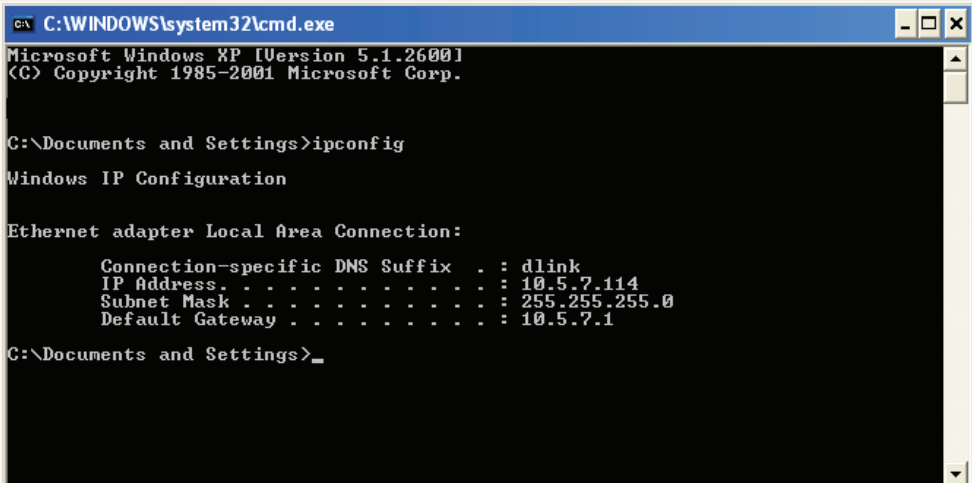

```
C:\WINDOWS\system32\cmd.exe
Microsoft Windows XP [Version 5.1.2600]
(C) Copyright 1985-2001 Microsoft Corp.

C:\Documents and Settings>ipconfig

Windows IP Configuration

Ethernet adapter Local Area Connection:

    Connection-specific DNS Suffix  . : dlink
    IP Address. . . . .                : 10.5.7.114
    Subnet Mask . . . . .              : 255.255.255.0
    Default Gateway . . . . .          : 10.5.7.1

C:\Documents and Settings>
```

## Statically Assign an IP Address

If you are not using a DHCP capable gateway/router, or you need to assign a static IP address, please follow the steps below:

### Step 1

Windows® 7- Click on **Start > Control Panel > Network and Internet > Network and Sharing Center**.

Windows® Vista - Click on **Start > Control Panel > Network and Internet > Network and Sharing Center > Manage Network Connections**.

Windows XP - Click on **Start > Control Panel > Network Connections**.

### Step 2

Right-click on the **Local Area Connection** which represents your D-Link network adapter and select **Properties**.

### Step 3

Highlight **Internet Protocol (TCP/IP)** and click **Properties**.

### Step 4

Click **Use the following IP address** and enter an IP address that is on the same subnet as your network or the LAN IP address on your router.

**Example:** If the router's LAN IP address is 192.168.0.1, make your IP address **192.168.0.X** where X is a number between 2 and 99. Make sure that the number you choose is not in use on the network. Set Default Gateway the same as the LAN IP address of your router (192.168.0.1).

Set Primary DNS the same as the LAN IP address of your router (**192.168.0.1**). The Secondary DNS is not needed or you may enter a DNS server from your ISP.

### Step 5

Click **OK** twice to save your settings.

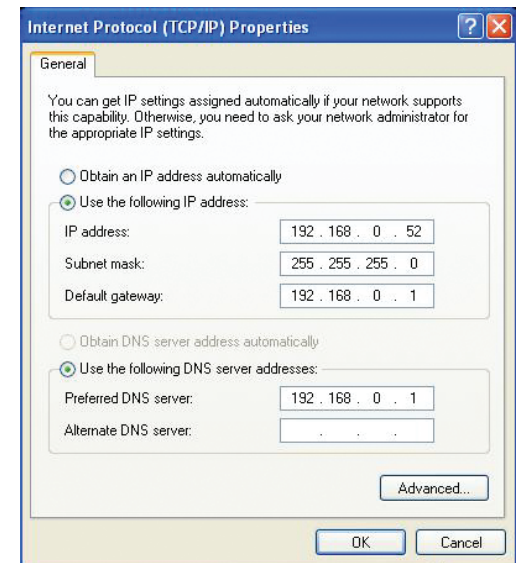

# Technical Specifications - Remote Control Unit

## Features

- Remote Controller
- Code system: NEC
- IR transmitter frequency: 38KHz

### Pan/ tilt direction key

Pressing the pan/tilt direction keys (up, down, left, right) will move the camera

### Home key

Pressing the Home key will move the camera to the home position.

### Calibration key

Pressing the Calibration key will calibrate both the pan and tilt positions by moving from end to end and will go to the corrected home position.

### Privacy key

Pressing the privacy key will tilt to the privacy position (privacy mode). Pressing it again privacy key will tilt the camera back to the previous position.

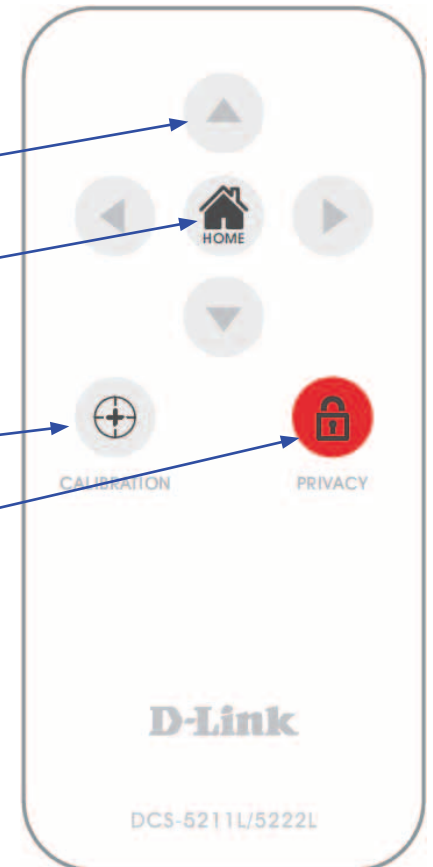

Matrix Index	Key Name	Key Code	Function
(1,2).....	Up	44	Tilt up
(2,1).....	Left	4C	Pan to the left
(2,2).....	Home	06	Return to home position
(2,3).....	Right	40	Pan to the right
(3,1).....	Calibration	07	Calibrate home position
(3,2).....	Down	48	Tilt down
(3,3).....	Privacy	0E	Tilt to privacy position.

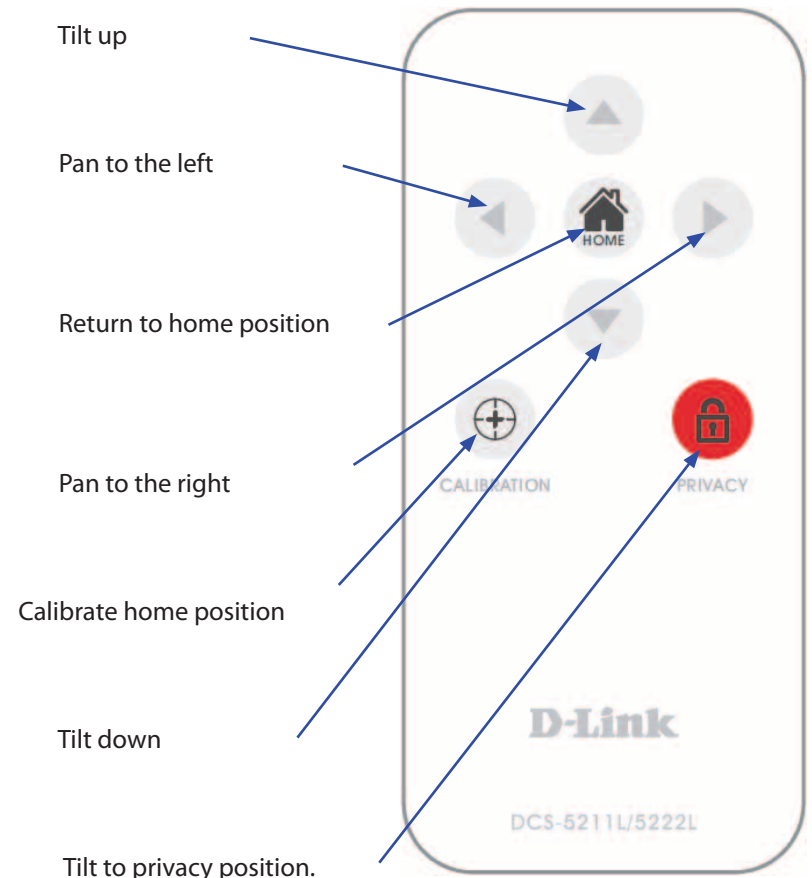

# Technical Specifications - I/O Terminal Application

Typically used in association with programming scripts for developing applications for motion detection, event triggering, alarm notification via e-mail, and a variety of external control functions. The 4-pin I/O Terminal Block is located on the rear panel and provides the interface of a photo-coupled switch output and a photo-coupled input.

## Connector Pin Assignment

Sign	FUNCTION	SPECIFICATION
DO-	Photo-Relay OUTPUT (Normal Open)	Close circuit current max. 70 mA AC, or 100 mA DC. On-Resistance max. 30 Ohm. Open circuit blocking voltage max. 240VAC or 340VDC
DO+	Photo-Relay OUTPUT(Common)	
DI-	Photo-Relay INPUT (-)	Active High voltage 2.5~25VDC Inactive Dropout voltage 0~1.5 VDC Internal on-current has limit at 7mA to protect the photo-relay.
DI+	Photo-Relay INPUT (+)	

## Monitoring and Controlling

By entering http requests in your browser's URL field, it is possible to:

- Monitor the status of digital input.
- Drive the output switch on or off.

## Interface Schematic

Output device (load) is driven by an external AC or DC power supply.

Input device (active control device) has an independent power supply.

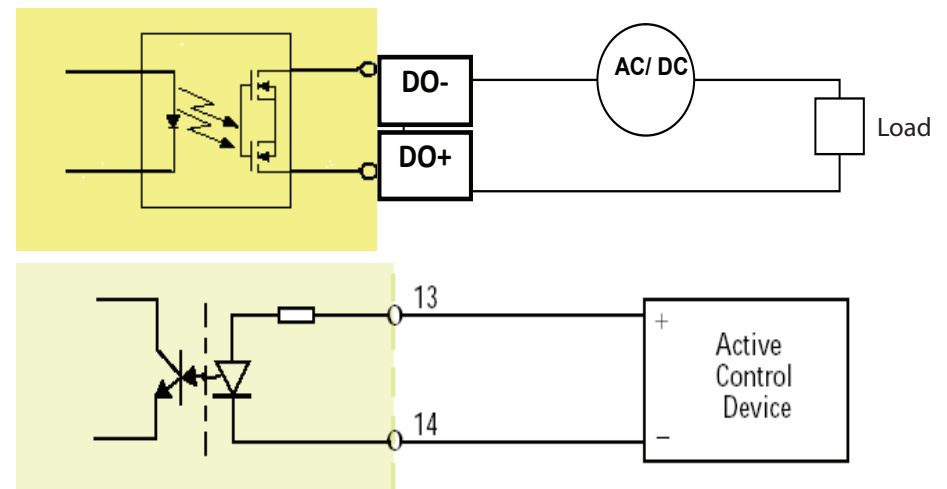



# Technical Specifications

## Networking Protocol

- IPv4, ARP, TCP, UDP, ICMP
- DHCP Client
- NTP Client (D-Link)
- DNS Client
- DDNS Client (D-Link)
- SMTP Client
- FTP Client
- HTTP Server
- UPNP Port Forwarding
- LLTD
- PPPoE
- RTP (Real Time Protocol)
- RTCP (Real Time Control Protocol)
- RTSP (Real Time Streaming Protocol)
- 3GPP(Video only)

## LAN

- 10/100BASE-TX port
- IEEE 802.3 compliant
- IEEE 802.3u compliant
- Supports Full-Duplex operation
- MDI/MDIX auto-negotiation
- 802.3x Flow Control support for Full-Duplex mode

## Wireless Connectivity

- 802.11g/n wireless with WEP/WPA/WPA2 Security
- WPS Support

## Sensor

- 1/4 inch WXGA (1280x800)

## Lens

- Focal length: 4.57mm, F1.9

## Microphone

- Signal/noise ratio: 40dB +/- 3dB, Omni-directional

## Reset Button

- Reset to factory default

## Video Codec

- H.264/MPEG4/MJPEG triple format compression simultaneously
- JPEG for still image

## Video Features

- Adjustable image size and quality
- Time stamp and text overlay
- Flip and Mirror
- Fully configurable motion detection window

## Maximum Resolution

- 1280x720

## Audio Codec

- PCM/ADPCM

## Light Sensitivity

- 1 lux@F1.0

## Digital Zoom

- Up to 4X

### **3A Control**

- AGC (Auto Gain Control)
- AWB ( Auto White Balance)
- AES (Auto Electronic Shutter)

### **Power**

- Input: 100-240VAC, 50/60Hz
- Output: 12VDC, 1.25A
- Powered by an external power adapter
- Maximum power consumption  
DCS-5222L: 10.5W @motor on ; 8.2W @motor off

### **Dimensions (WxDxH)**

- 114.0mm x 114.0mm x 125.0mm (without bracket and stand)

### **Weight**

- 540g (without bracket and stand)

### **Operation Temperature**

- 0° to 40°C (32° to 104°F)

### **Storage Temperature**

- -20° to 70°C (-4° to 158°F)

### **Humidity**

- 20-80% RH non-condensing

### **Emission (EMI), Safety & Other Certifications**

- FCC Class B
- IC
- C-Tick
- CE